

SE2306
N-Channel Enhancement Mode Field Effect Transistor

Revision:B

Features

- $V_{DS} = 20V, I_D = 6A$
 $R_{DS(ON)} < 34.5m\Omega @ V_{GS} = 2.5V$
 $R_{DS(ON)} < 24.5m\Omega @ V_{GS} = 4.5V$
- High Power and current handling capability
- Lead free product is acquired
- Surface Mount Package

Applications

- Load switch
- Power management

Construction

- Silicon epitaxial planer

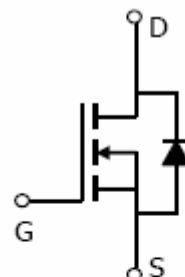

(SOT-23)
Top View

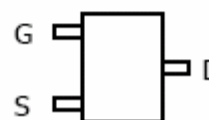

Absolute maximum ratings (Ta=25°C)

Parameter	Symbol	Limits	Unit
Drain-Source Voltage	V_{DS}	20	V
Gate-Source Voltage	V_{GS}	± 10	V
Drain Current-Continuous@ Current-Pulsed (Note 1)	I_D	6	A
	I_{DM}	25	A
Maximum Power Dissipation	P_D	1.5	W
Operating Junction and Storage Temperature Range	T_J, T_{STG}	-55 To 150	°C

THERMAL CHARACTERISTICS

Thermal Resistance, Junction-to-Ambient (Note 2)	$R_{\theta JA}$	83	°C/W
--	-----------------	----	------

Electrical characteristics (Ta=25°C)

Parameter	Symbol	Conditions	Min.	Typ.	Max.	Unit
OFF CHARACTERISTICS						
Drain-Source Breakdown Voltage	BV_{DSS}	$V_{GS} = 0V, I_D = 250\mu A$	20			V
Zero Gate Voltage Drain Current	I_{DSS}	$V_{DS} = 20V, V_{GS} = 0V$			0.8	μA
Gate-Body Leakage Current	I_{GSS}	$V_{GS} = \pm 10V, V_{DS} = 0V$			± 80	nA
ON CHARACTERISTICS (Note 3)						

SE2306

Gate Threshold Voltage	$V_{GS(th)}$	$V_{DS}=V_{GS}, I_D=250\mu A$	0.45	0.65	1.2	V
Drain-Source On-State Resistance	$R_{DS(ON)}$	$V_{GS}=4.5V, I_D=4.5A$		21	24.5	mΩ
		$V_{GS}=2.5V, I_D=3.5A$		30	34.5	mΩ
Forward Transconductance	g_{FS}	$V_{DS}=5V, I_D=4.5A$	3			S
DYNAMIC CHARACTERISTICS (Note4)						
Input Capacitance	C_{iss}	$V_{DS}=8V, V_{GS}=0V,$ $F=1.0MHz$		600		PF
Output Capacitance	C_{oss}			330		PF
Reverse Transfer Capacitance	C_{rss}			140		PF
SWITCHING CHARACTERISTICS (Note 4)						
Turn-on Delay Time	$t_{d(on)}$	$V_{DD}=10V, I_D=1A$ $V_{GS}=4.5V, R_{GEN}=6\Omega$		10	20	nS
Turn-on Rise Time	t_r			11	25	nS
Turn-Off Delay Time	$t_{d(off)}$			35	70	nS
Turn-Off Fall Time	t_f			30	60	nS
Total Gate Charge	Q_g	$V_{DS}=10V, I_D=6A,$ $V=4.5V$		10	15	nC
Gate-Source Charge	Q_{gs}			2.3		nC
Gate-Drain Charge	Q_{gd}			3		nC
DRAIN-SOURCE DIODE CHARACTERISTICS						
Diode Forward Voltage (Note 3)	V_{SD}	$V=0V, I=1.7A$			1.2	V
Diode Forward Current (Note 2)	I_S			1.7		A

NOTES:

1. Repetitive Rating: Pulse width limited by maximum junction temperature.
2. Surface Mounted on FR4 Board, $t \leq 10$ sec.
3. Pulse Test: Pulse Width $\leq 300\mu s$, Duty Cycle $\leq 2\%$.
4. Guaranteed by design, not subject to production testing.

TYPICAL ELECTRICAL AND THERMAL CHARACTERISTICS

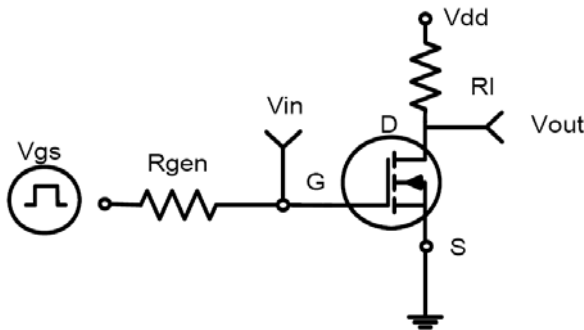

Figure 1: Switching Test Circuit

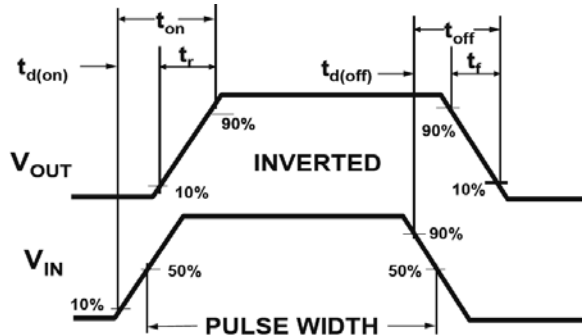

Figure 2: Switching Waveforms

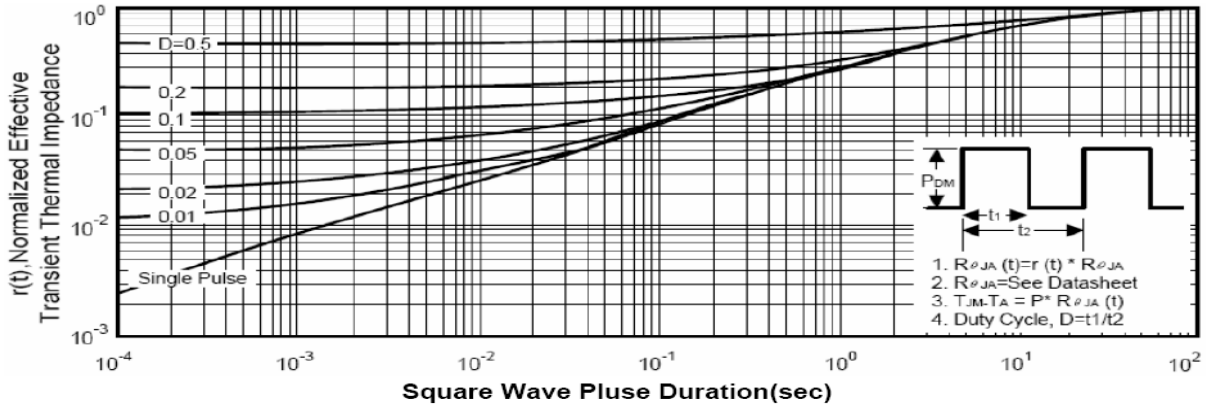
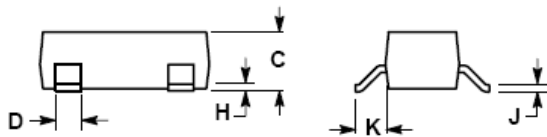
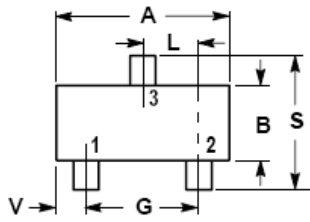

Figure 3: Normalized Maximum Transient Thermal Impedance

SOT-23



NOTES:

1. DIMENSIONING AND TOLERANCING PER ANSI Y14.5M, 1982
2. CONTROLLING DIMENSION: INCH.

DIM	INCHES		MILLIMETERS	
	MIN	MAX	MIN	MAX
A	0.1102	0.1197	2.80	3.04
B	0.0472	0.0551	1.20	1.40
C	0.0350	0.0440	0.89	1.11
D	0.0150	0.0200	0.37	0.50
G	0.0701	0.0807	1.78	2.04
H	0.0005	0.0040	0.013	0.100
J	0.0034	0.0070	0.085	0.177
K	0.0140	0.0285	0.35	0.69
L	0.0350	0.0401	0.89	1.02
S	0.0830	0.1039	2.10	2.64
V	0.0177	0.0236	0.45	0.60

The SINO-IC logo is a registered trademark of ShangHai Sino-IC Microelectronics Co., Ltd.

© 2005 SINO-IC – Printed in China – All rights reserved.

SHANGHAI SINO-IC MICROELECTRONICS CO., LTD

Add: Building 3, Room 3401-03, No.200 Zhangheng Road, ZhangJiang Hi-Tech Park, Pudong, Shanghai 201203, China

Phone: +86-21-33932402 33932403 33932405 33933508 33933608

Fax: +86-21-33932401

Email: webmaster@sino-ic.com

Website: <http://www.sino-ic.com>