

**SED5853**

**P-Channel Enhancement Mode Field Effect Transistor with Schottky Diode**

**General Description**

The SED5853 uses advanced trench technology to provide excellent  $R_{DS(ON)}$  and low gate charge. A Schottky diode is provided to facilitate the implementation of a bidirectional blocking switch, or for DC-DC conversion applications. Standard Product SED5853 is Pb-free (meets ROHS specifications).

**Features**

$V_{DS}(V) = -20V$   
 $I_D = -3.4A (V_{GS} = -4.5V)$   
 $R_{DS(ON)} < 90m\Omega (V_{GS} = -4.5V)$   
 $R_{DS(ON)} < 120m\Omega (V_{GS} = -2.5V)$   
 $R_{DS(ON)} < 160m\Omega (V_{GS} = -1.8V)$   
**SCHOTTKY**  
 $V_{DS}(V) = 20V, I_F = 1A, V_F < 0.5V @ 0.5A$



**DFN3X2-8L**

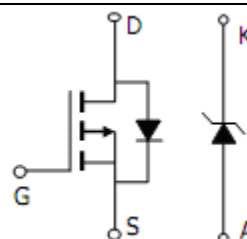
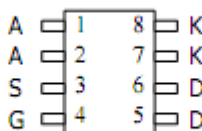

**Absolute maximum ratings (Ta=25°C)**

Parameter	Symbol	MOSFET	Schottky	Unit
Drain-Source Voltage	$V_{DS}$	-20		V
Gate-Source Voltage	$V_{GS}$	$\pm 8$		V
Continuous Drain Current <sup>A</sup>	$I_D$	$T_A = 25^\circ C$	-3.4	A
		$T_A = 70^\circ C$	-2.7	
Pulsed Drain Current <sup>B</sup>	$I_{DM}$	-15		
Schottky reverse voltage	$V_{KA}$		20	V
Continuous Forward Current <sup>A</sup>	$I_F$	$T_A = 25^\circ C$	1.9	A
		$T_A = 70^\circ C$	1.2	
Pulsed Forward Current <sup>B</sup>	$I_{FM}$		7	
Power Dissipation	$P_D$	$T_A = 25^\circ C$	1.7	W
		$T_A = 70^\circ C$	1.1	
Junction and Storage Temperature Rang	$I_J, I_{STG}$	-55 to 150	-55 to 150	$^\circ C$

**Parameter: Thermal Characteristics MOSFET**

Parameter	Symbol	Typ	Max	Units
Maximum Junction-to-Ambient <sup>A</sup>	$R_{\theta JA}$	51	75	$^\circ C/W$
Maximum Junction-to-Ambient <sup>A</sup>		Steady-State	88	
Maximum Junction-to-Lead <sup>C</sup>	$R_{\theta JL}$	28	35	

**Thermal Characteristics Schottky**

Parameter	Symbol	Typ	Max	Units
Maximum Junction-to-Ambient <sup>A</sup>	$R_{\theta JA}$	66	80	$^\circ C/W$
Maximum Junction-to-Ambient <sup>A</sup>		Steady-State	95	
Maximum Junction-to-Lead <sup>C</sup>	$R_{\theta JL}$	40	50	

<b>Electrical Characteristics (T<sub>J</sub>=25°C unless otherwise note)</b>						
Symbol	Parameter	Conditions	Min	Typ	Max	Units
<b>STATIC PARAMETERS</b>						
B <sub>V</sub> DSS	Drain-Source Breakdown Voltage	I <sub>D</sub> = -250uA, V <sub>GS</sub> =0V	-20			V
I <sub>DSS</sub>	Zero Gate Voltage Drain Current	V <sub>DS</sub> = -16V, V <sub>GS</sub> =0V			-1	uA
		V <sub>DS</sub> = -16V, V <sub>GS</sub> =0V (T <sub>J</sub> =55°C)			-5	uA
I <sub>GSS</sub>	Gate-Body leakage current	V <sub>DS</sub> =0V, V <sub>GS</sub> = ±8V			±100	nA
V <sub>GS(IN)</sub>	Gate Threshold Voltage	V <sub>DS</sub> = V <sub>GS</sub> , I <sub>D</sub> = -250uA	-0.3	-0.63	-1	V
I <sub>D(ON)</sub>	On state drain current	V <sub>GS</sub> = -4.5V, V <sub>DS</sub> =-5V	-15			A
R <sub>DS(ON)</sub>	Static Drain-Source On-Resistance	V <sub>GS</sub> = -4.5V, I <sub>D</sub> = -3.4A		73	90	mΩ
		V <sub>GS</sub> =-4.5V, I <sub>D</sub> =-3.4A(T <sub>J</sub> =125°C)		110	135	mΩ
		V <sub>GS</sub> = -2.5V, I <sub>D</sub> = -2.5A		99	120	mΩ
		V <sub>GS</sub> = -1.8V, I <sub>D</sub> = -1.5A		133	160	mΩ
g <sub>FS</sub>	Forward Transconductance	V <sub>GS</sub> = -5V, I <sub>D</sub> = -3.4A	4	7		S
V <sub>SD</sub>	Diode Forward Voltage	V <sub>GS</sub> = 0V, I <sub>S</sub> = -1A		-0.83	-1	V
I <sub>S</sub>	Maximum Body-Diode Continuous Current				-2	A
<b>DYNAMIC PARAMETERS</b>						
C <sub>ISS</sub>	Input Capacitance			540		pF
C <sub>OSS</sub>	Output Capacitance	V <sub>GS</sub> = 0V, V <sub>DS</sub> = -10V, f= 1MHz		72		pF
C <sub>RSS</sub>	Reverse Transfer Capacitance			49		pF
R <sub>g</sub>	Gate resistance	V <sub>GS</sub> = 0V, V <sub>DS</sub> = 0V, f= 1MHz		12		Ω
<b>SWITCHING PARAMETERS</b>						
Q <sub>g</sub>	Total Gate Charge	V <sub>GS</sub> =-4.5V, V <sub>DS</sub> =-10V, I <sub>D</sub> = -3.4A		6.1		nC
Q <sub>gs</sub>	Gate Source Charge			0.6		nC
Q <sub>gd</sub>	Gate Drain Charge			16		nC
T <sub>D(on)</sub>	Turn-On DelayTime	V <sub>GS</sub> = -4.5V, V <sub>DS</sub> = -10V, R <sub>L</sub> = 2.9Ω, R <sub>GEN</sub> = 3Ω		10		ns
t <sub>r</sub>	Turn-On Rise Time			12		ns
T <sub>D(off)</sub>	Turn-Off DelayTime			44		ns
t <sub>f</sub>	Turn-Off Fall Time			22		ns
t <sub>rr</sub>	Reverse Recovery Time	I <sub>F</sub> = -3.4A, dI/dt=100A/us		21		ns
Q <sub>rr</sub>	Reverse Recovery Charge	I <sub>F</sub> = -3.4A, dI/dt=100A/us		7.5		nC
<b>SCHOTTKY PARAMETERS</b>						
V <sub>F</sub>	Forward Voltage Drop	I <sub>F</sub> = 0.5A		0.39	0.5	V
I <sub>rm</sub>	Maximum reverse leakage current	V <sub>R</sub> =16V			0.1	mA
		V <sub>R</sub> = 16V, T <sub>J</sub> =125°C			20	
C <sub>T</sub>	Junction Capacitance	V <sub>R</sub> = 10V		34		pF
t <sub>rr</sub>	SchottkyReverse Recovery Time	I <sub>F</sub> = 1A, dI/dt=100A/us		5.2	10	Ns
Q <sub>rr</sub>	Schottky Reverse Recovery Charge	I <sub>F</sub> = 1A, dI/dt=100A/us		0.8		nC

TYPICAL ELECTRICAL AND THERMAL CHARACTERISTICS

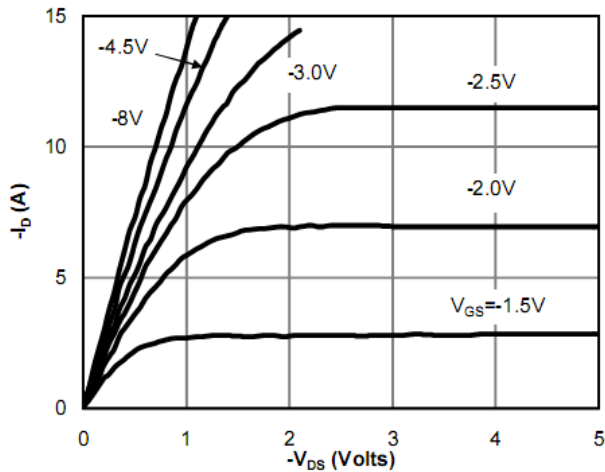

Fig 1: On-Region Characteristics

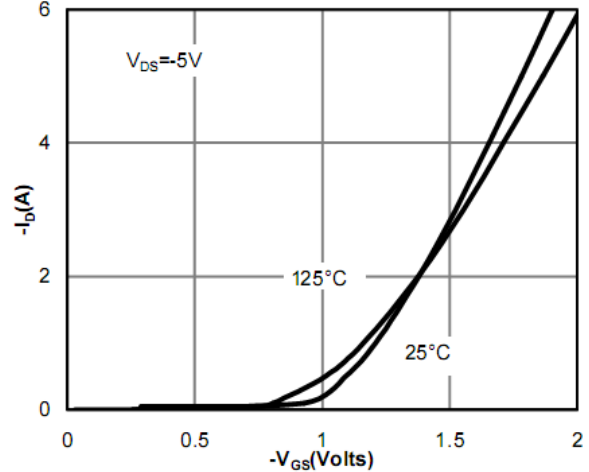

Figure 2: Transfer Characteristics

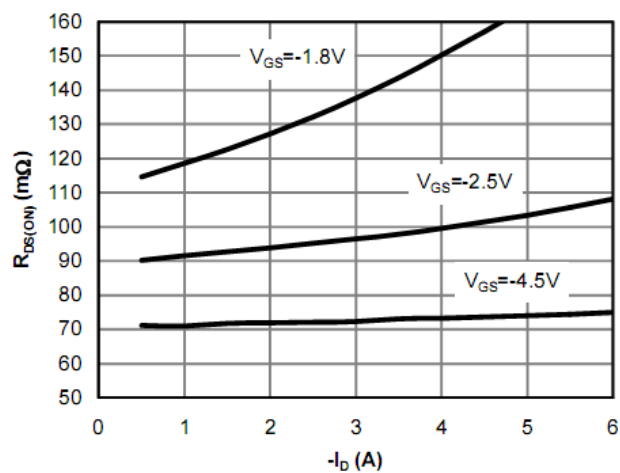

Figure 3: On-Resistance vs. Drain Current and Gate Voltage

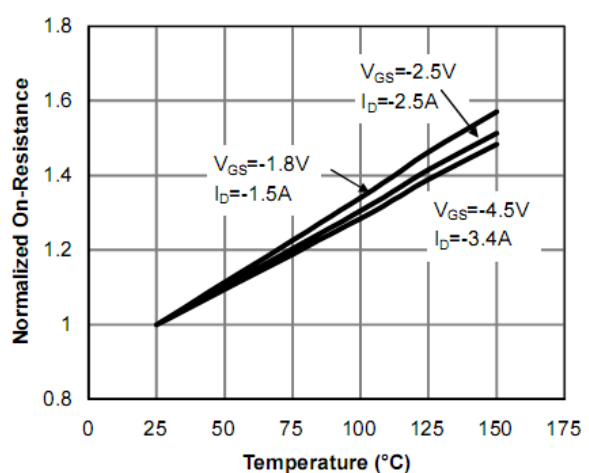

Figure 4: On-Resistance vs. Junction Temperature

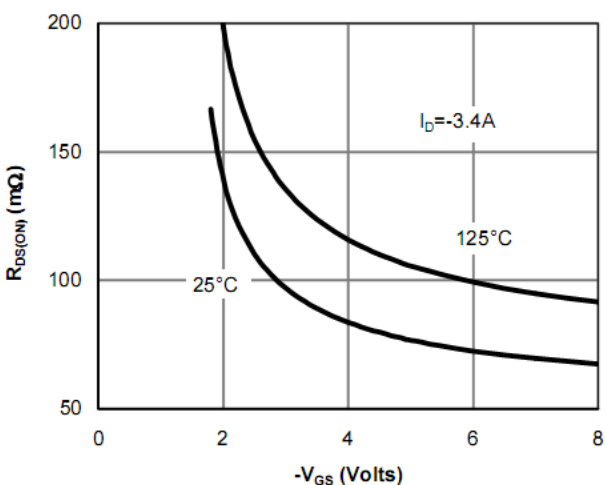

Figure 5: On-Resistance vs. Gate-Source Voltage

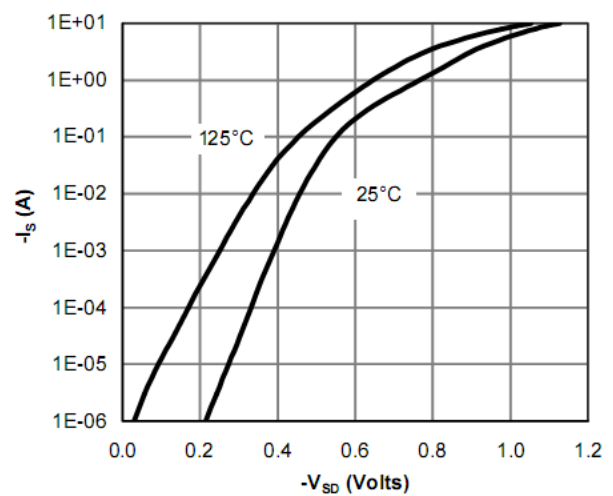

Figure 6: Body-Diode Characteristics

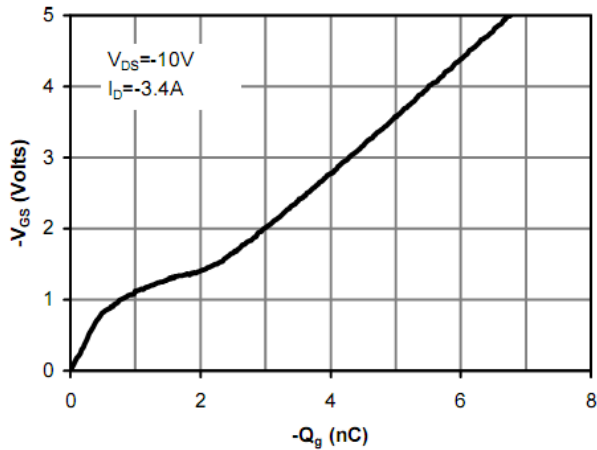

Figure 7: Gate-Charge Characteristics

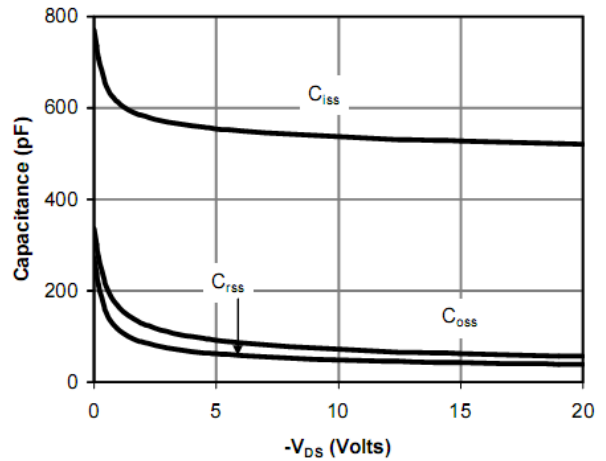

Figure 8: Capacitance Characteristics

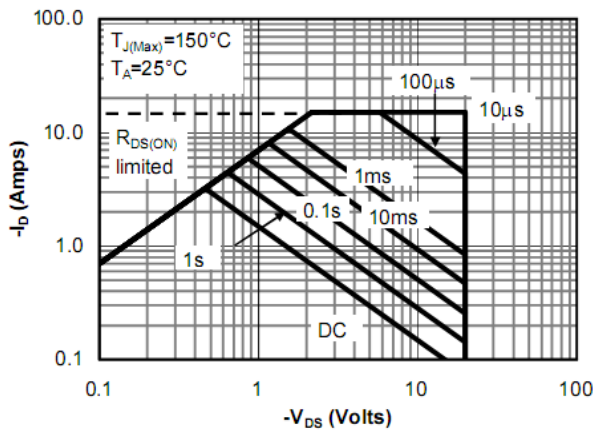

Figure 9: Maximum Forward Biased Safe Operating Area (Note E)

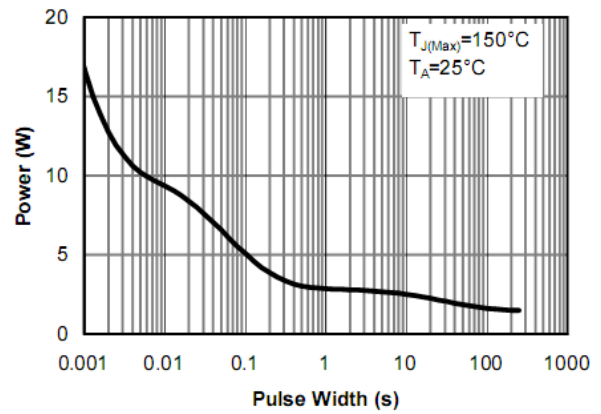

Figure 10: Single Pulse Power Rating Junction-to-Ambient (Note E)

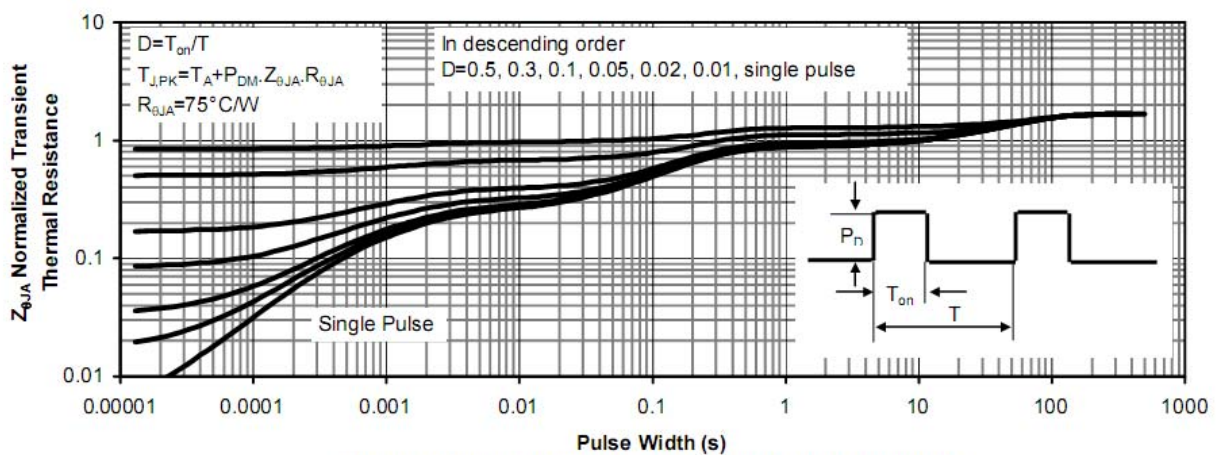

Figure 11: Normalized Maximum Transient Thermal Impedance

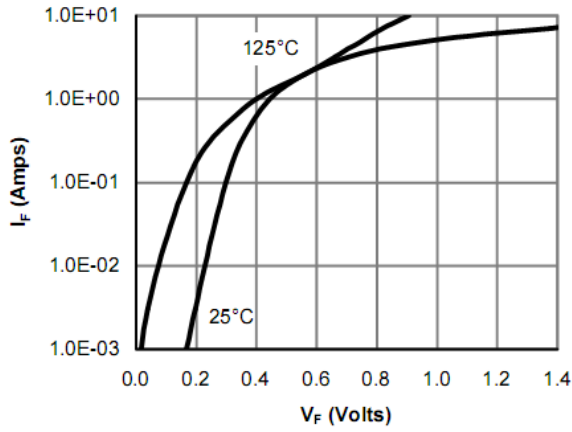

Figure 12: Schottky Forward Characteristics

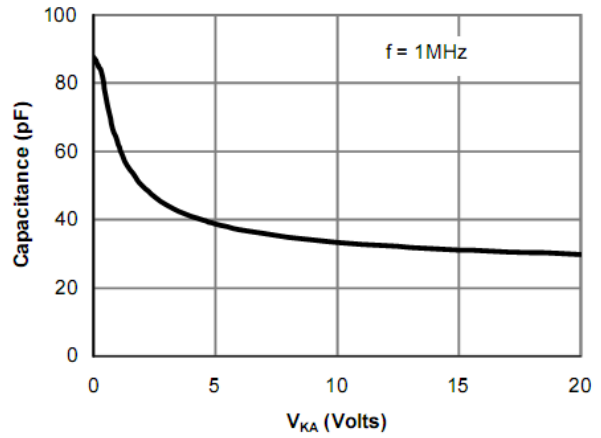

Figure 13: Schottky Capacitance Characteristics

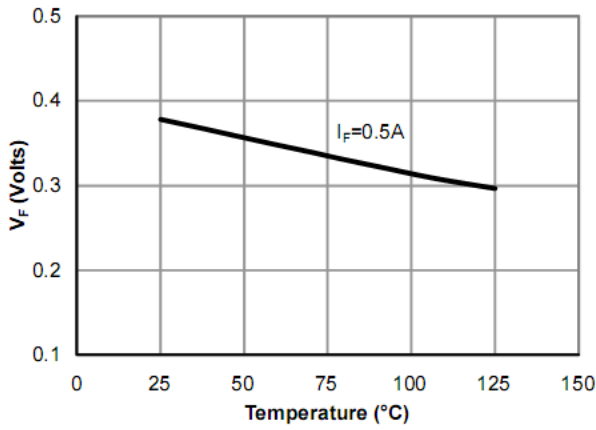

Figure 14: Schottky Forward Drop vs. Junction Temperature

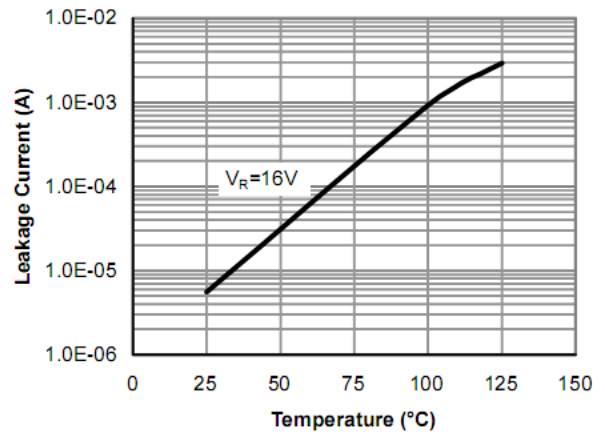

Figure 15: Schottky Leakage current vs. Junction Temperature

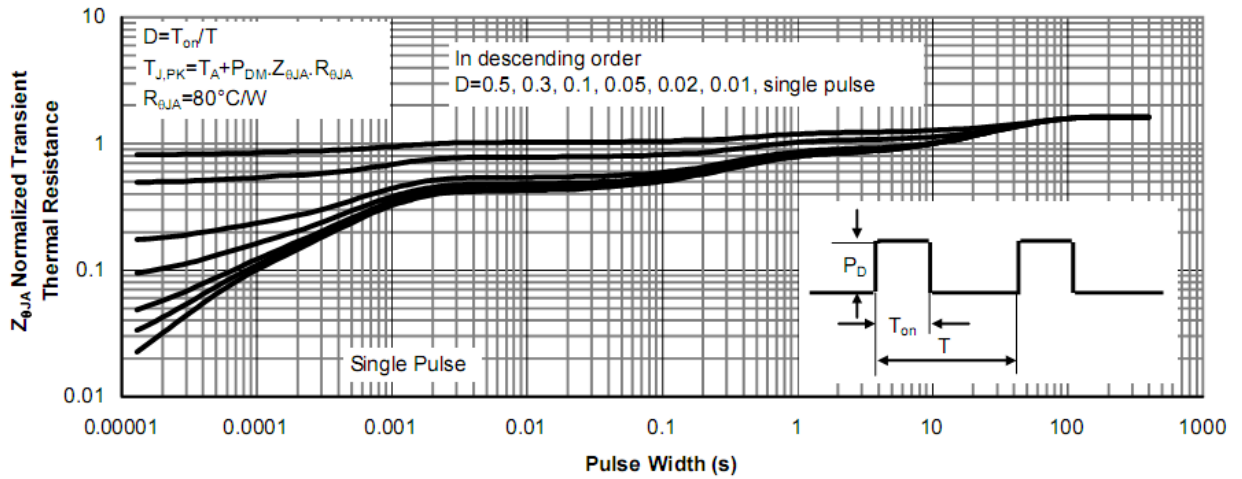
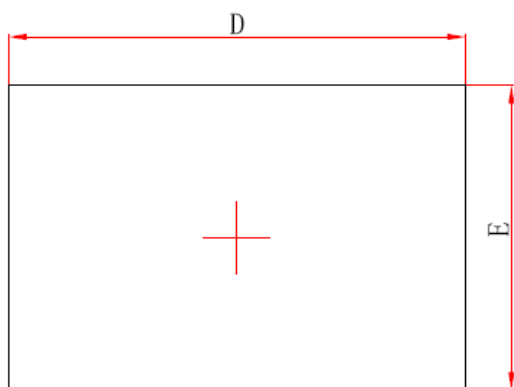
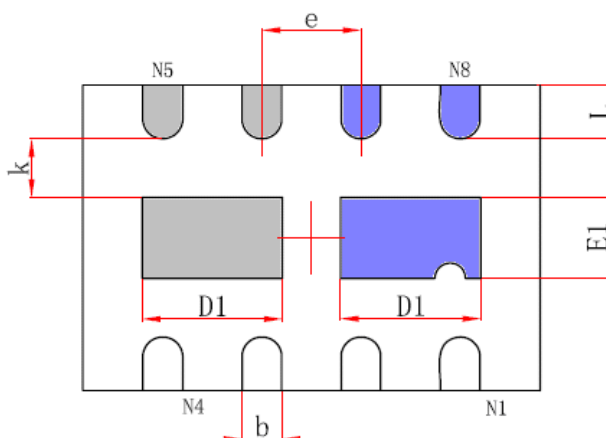

Figure 16: Schottky Normalized Maximum Transient Thermal Impedance

**DFNWB3\*2-8L(P0.65T0.75/0.85) PACKAGE OUTLINE DIMENSIONS**



**Top View**



**Bottom View**

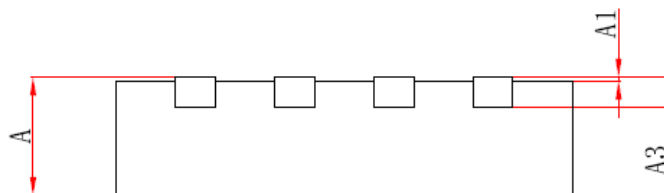

Symbol	Dimensions In Millimeters		Dimensions In Inches	
	Min.	Max.	Min.	Max.
A	0.700/0.800	0.800/0.900	0.028/0.031	0.031/0.035
A1	0.000	0.050	0.000	0.002
A3	0.203REF.		0.008REF.	
D	2.900	3.100	0.114	0.122
E	1.900	2.100	0.075	0.083
D1	0.820	1.020	0.032	0.040
E1	0.430	0.630	0.017	0.025
k	0.200MIN.		0.008MIN.	
b	0.250	0.350	0.010	0.014
e	0.650TYP.		0.026TYP.	
L	0.250	0.450	0.010	0.018

The SINO-IC logo is a registered trademark of ShangHai Sino-IC Microelectronics Co., Ltd.

© 2005 SINO-IC – Printed in China – All rights reserved.

**SHANGHAI SINO-IC MICROELECTRONICS CO., LTD**

**Add:** Building 3, Room 3401-03, No.200 Zhangheng Road, ZhangJiang Hi-Tech Park, Pudong, Shanghai 201203, China

**Phone:** +86-21-33932402 33932403 33932405 33933508 33933608

**Fax:** +86-21-33932401

**Email:** [webmaster@sino-ic.com](mailto:webmaster@sino-ic.com)

**Website:** <http://www.sino-ic.com>