

SE8810A
Dual N-Channel Enhancement Mode Field Effect Transistor

Revision:A

Features

For a single mosfet

- $V_{DSS} = 20\text{ V}$
- $R_{DS(ON)} < 20\text{m}\Omega$ @ $V_{GS}=4.5\text{V}$ @ $I_{DS}=7\text{A}$
- $R_{DS(ON)} < 25\text{m}\Omega$ @ $V_{GS}=2.5\text{V}$ @ $I_{DS}=4\text{A}$

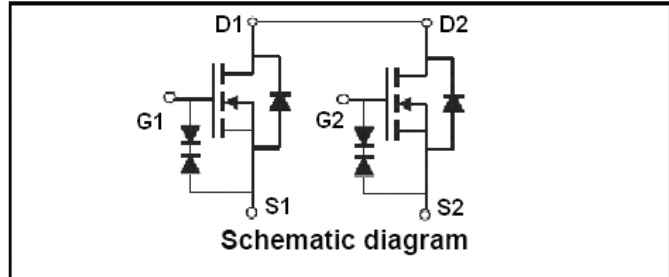

Applications

- Battery protection
- Load switch
- Power management

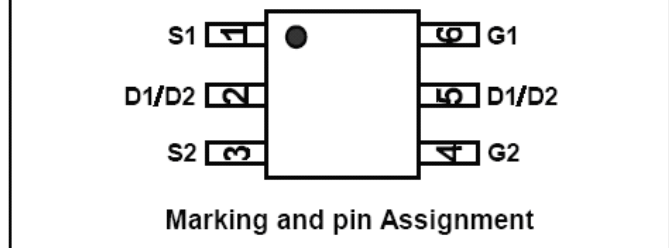

Construction

- Silicon epitaxial planer



Absolute Maximum Ratings

Parameter		Symbol	Rating	Units
Drain-Source Voltage		V_{DS}	20	V
Gate-Source Voltage		V_{GS}	± 12	V
Drain Current (Note 1)	Continuous	I_D	7	A
	Pulsed	I_{DM}	28	
Drain-Source Diode Forward Current		I_S	1.7	A
Maximum Power Dissipation		P_D	1.5	W
Operating Junction Temperature Range		T_J	-55 to 150	$^{\circ}\text{C}$
Storage Temperature Range		T_{STG}		

SE8810A

Electrical Characteristics (T _J =25°C unless otherwise noted)						
Symbol	Parameter	Test Conditions	Min	Typ	Max	Units
OFF CHARACTERISTICS						
B _{VDSS}	Drain-Source Breakdown Voltage	I _D =250μA, V _{GS} =0 V	20			V
I _{DSS}	Zero Gate Voltage Drain Current	V _{DS} =16 V, V _{GS} =0 V			1	μA
I _{GSS}	Gate-Body leakage	V _{DS} =0 V, V _{GS} =±12 V			±10	μA
ON CHARACTERISTICS						
V _{GS(th)}	Gate Threshold Voltage	V _{DS} =V _{GS} I _D =250μA	0.5	0.8	1.2	V
R _{DS(ON)}	Static Drain-Source On-Resistance	V _{GS} =4.5V, I _D =7A	-	17	20	mΩ
		V _{GS} =2.5V, I _D =5A	-	20	25	
g _{FS}	Forward Transconductance	V _{DS} =5V, I _D =5A		19		S
DYNAMIC PARAMETERS						
C _{iss}	Input Capacitance	V _{GS} =0V, V _{DS} =8V, f=1.0MHz		693		pF
C _{oss}	Output Capacitance			189		pF
C _{rss}	Reverse Transfer Capacitance			136		pF
SWITCHING PARAMETERS						
Q _g	Total Gate Charge	V _{GS} =4.0V		11		nC
Q _{gs}	Gate Source Charge	V _{DS} =10V		1.8		
Q _{gd}	Gate Drain Charge	I _D =5A		4.9		
t _{d(on)}	Turn-On DelayTime	V _{GEN} =4.0V		31		ns
t _{d(off)}	Turn-Off DelayTime	R _{GEN} =10Ω		96		
t _{d(r)}	Turn-On Rise Time	V _{DD} =10V		62		
t _{d(f)}	Turn-Off Fall Time	I _D =1A		40		

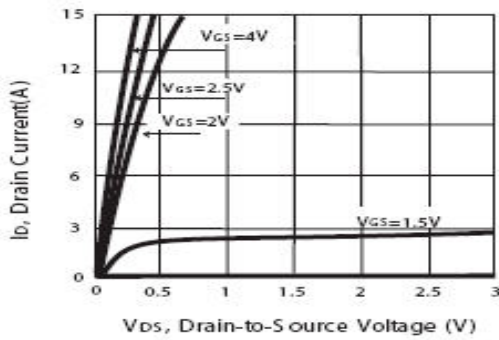

Figure 1. Output Characteristics

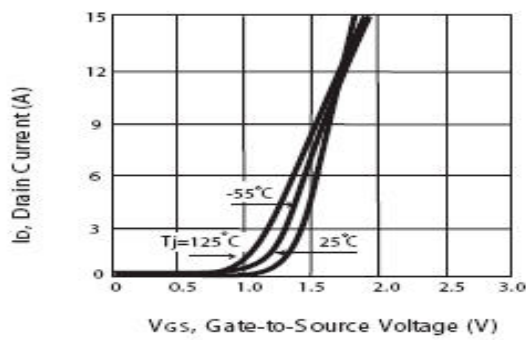

Figure 2. Transfer Characteristics

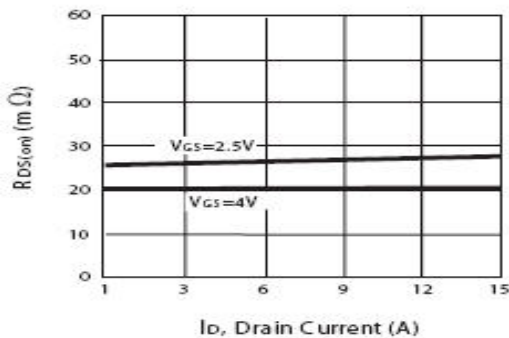

Figure 3. On-Resistance vs. Drain Current and Gate Voltage

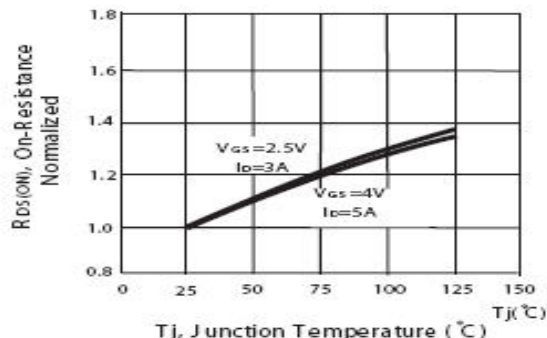

Figure 4. On-Resistance Variation with Drain Current and Temperature

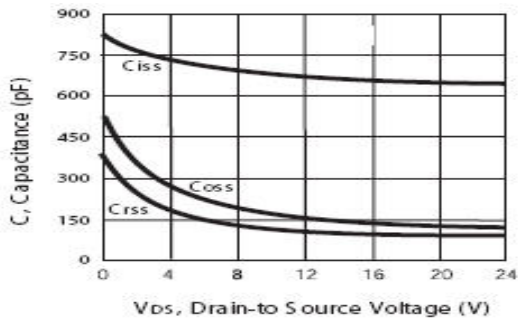

Figure 9. Capacitance

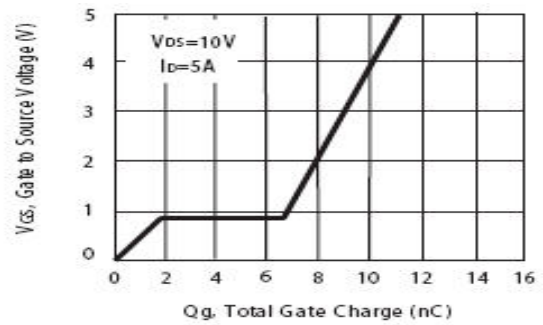

Figure 10. Gate Charge

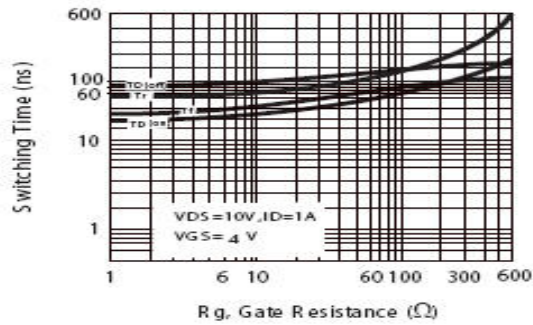

Figure 11. switching characteristics

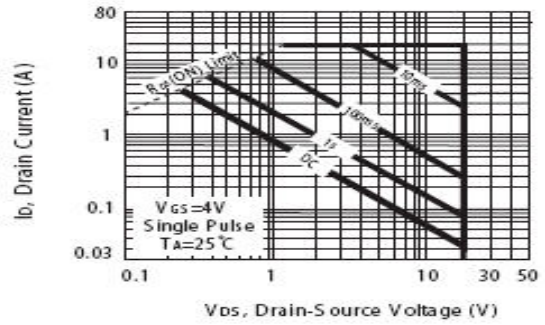

Figure 12. Maximum Safe Operating Area

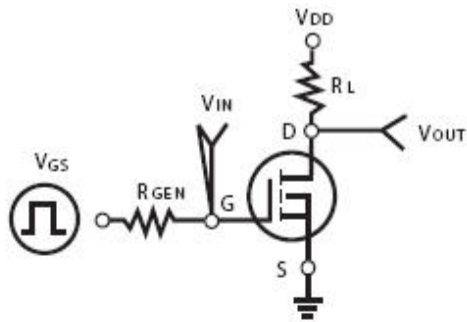

Figure 11. Switching Test Circuit

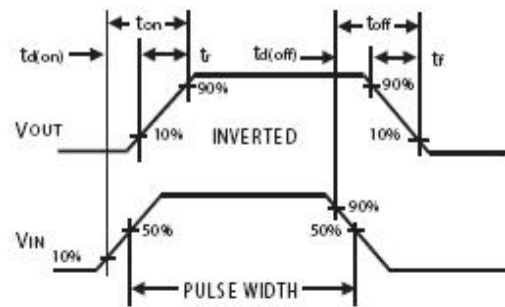
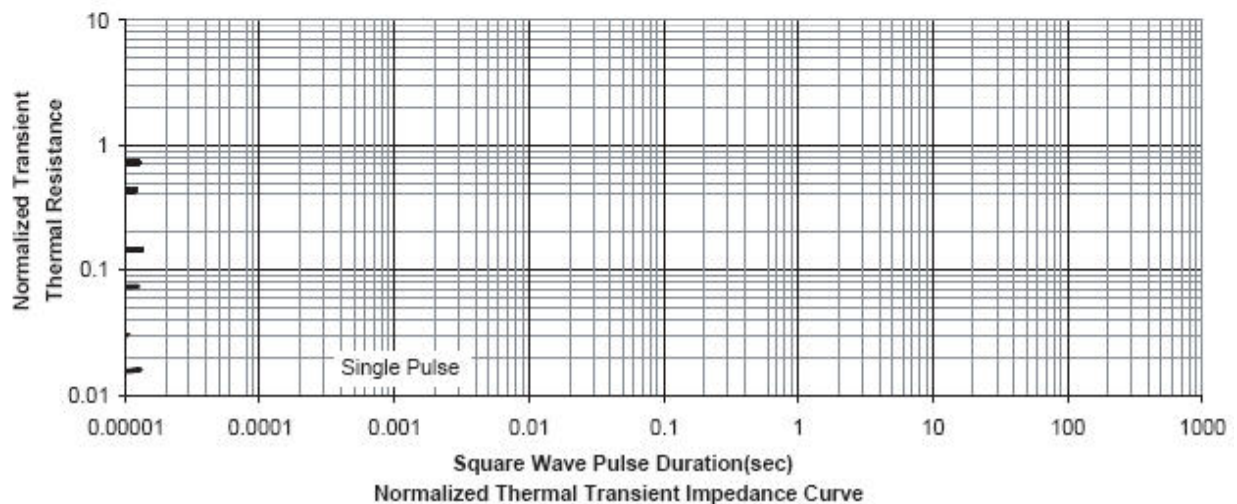

Figure 12. Switching Waveforms



Normalized Thermal Transient Impedance Curve

SE8810A

PACKAGE DIMENSION (Unit:mm)

SOT-23-6

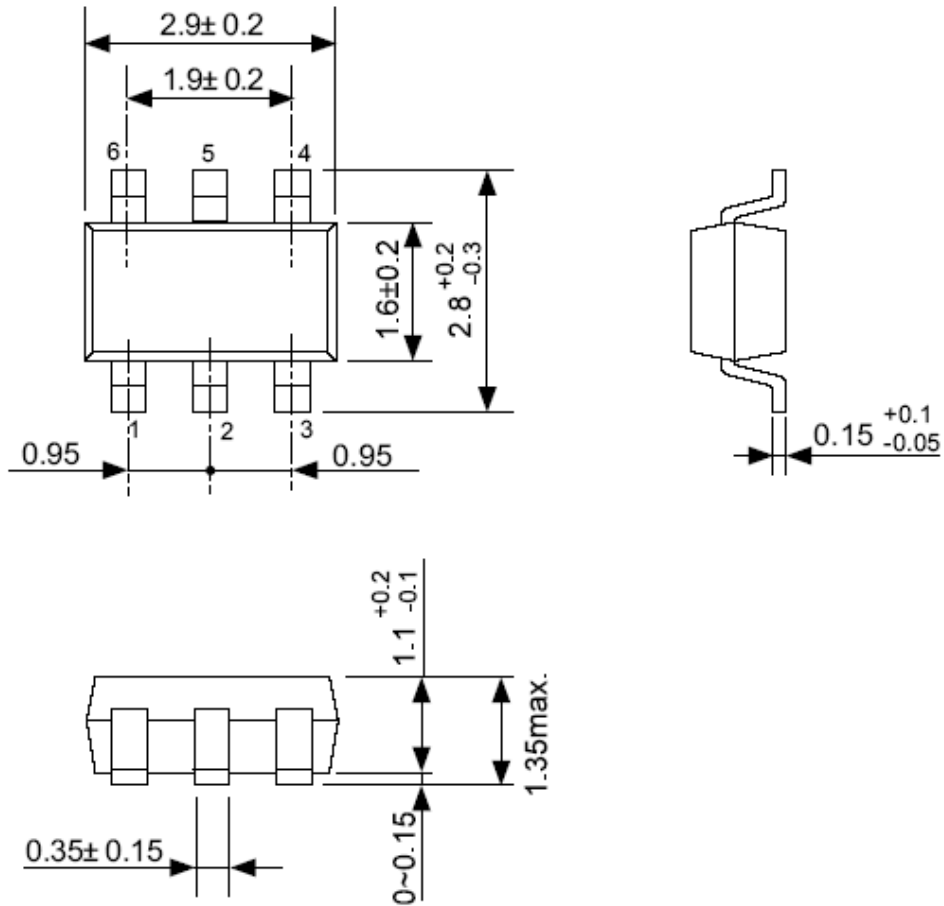

The SINO-IC logo is a registered trademark of ShangHai Sino-IC Microelectronics Co., Ltd.

© 2005 SINO-IC – Printed in China – All rights reserved.

SHANGHAI SINO-IC MICROELECTRONICS CO., LTD

Add: Building 3, Room 3401-03, No.200 Zhangheng Road, ZhangJiang Hi-Tech Park, Pudong, Shanghai 201203, China

Phone: +86-21-33932402 33932403 33932405 33933508 33933608

Fax: +86-21-33932401

Email: webmaster@sino-ic.com

Website: <http://www.sino-ic.com>