

SE7401U
20V P-Channel Enhancement-Mode MOSFET

Revision:B

General Description

The MOSFETs from SINO-IC provide the best combination of fast switching, low on-resistance and cost-effectiveness.

General Description

Thigh Density Cell Design For Ultra Low On-Resistance Fully Characterized Avalanche Voltage and Current Improved Shoot-Through FOM

- Simple Drive Requirement
- Small Package Outline
- Surface Mount Device
- Pb-Free package is available

Features

For a single mosfet

- $V_{DS} = -20\text{ V}$
- $R_{DS(ON)} = 120\text{m}\Omega @ V_{GS}=-4.50\text{V} @ I_{ds}=-2.0\text{A}$
- $R_{DS(ON)} = 150\text{m}\Omega @ V_{GS}=-2.50\text{V} @ I_{ds}=-1.8\text{A}$
- $R_{DS(ON)} = 170\text{m}\Omega @ V_{GS}=-1.80\text{V} @ I_{ds}=-1.8\text{A}$

Pin configurations

See Diagram below

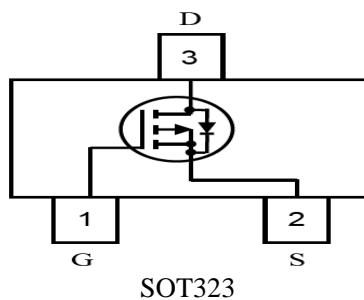

Absolute Maximum Ratings

Parameter		Symbol	Rating	Units
Drain-Source Voltage		V_{DS}	-20	V
Gate-Source Voltage		V_{GS}	± 8	V
Drain Current (Note 1)	Continuous	I_D	-2.2	A
	Pulsed		-7	
Total Power Dissipation	@ $T_A=25^\circ\text{C}$	P_D	0.9	W
	@ $T_A=75^\circ\text{C}$		0.57	
Operating Junction Temperature Range		T_J	-55 to 150	$^\circ\text{C}$

SE7401U

Electrical Characteristics (T _J =25°C unless otherwise noted)						
Symbol	Parameter	Test Conditions	Min	Typ	Max	Units
OFF CHARACTERISTICS (Note 2)						
B _V DSS	Drain-Source Breakdown Voltage	I _D =-250 μ A, V _{GS} =0 V	-20			V
I _{DSS}	Zero Gate Voltage Drain Current	V _{DS} =20 V, V _{GS} =0 V			-1	μ A
I _{GSS}	Gate-Body leakage current	V _{DS} =0 V, V _{GS} =±10 V			±0.1	μ A
V _{GS(th)}	Gate Threshold Voltage	V _{DS} =V _{GS} I _D =-250 μ A	-0.4		-0.9	V
R _{DS(on)}	Static Drain-Source On-Resistance ²	V _{GS} =-4.5V, I _D =-2.0 A	-	100	120	mΩ
		V _{GS} =-2.5V, I _D =-1.8A	-	120	150	
		V _{GS} =-1.8V, I _D =-1.8A		140	170	
g _{FS}	Forward Transconductance	V _{DS} =5V, I _D =2A		6.5		S
DYNAMIC PARAMETERS						
C _{iss}	Input Capacitance	V _{GS} =0V, V _{DS} =10V, f=1MHz		373		pF
C _{oss}	Output Capacitance			138		pF
C _{rss}	Reverse Transfer Capacitance			52		pF
SWITCHING PARAMETERS						
Q _g	Total Gate Charge ²	V _{GS} =-4.5V, V _{DS} =-6V, I _D =-2.0A		15.2		nC
Q _{gs}	Gate Source Charge			5.5		nC
Q _{gd}	Gate Drain Charge			2.7		nC
t _{d(on)}	Turn-On DelayTime ²	V _{GS} =-4.5V, V _{DD} =-6V, R _L =6 Ω, R _G =6 Ω I _D =-1A			17.3	ns
t _{d(off)}	Turn-Off DelayTime				36.0	
t _{d(r)}	Turn-On Rise Time				3.7	
t _{d(f)}	Turn-Off Fall Time				3.2	

Typical Characteristics

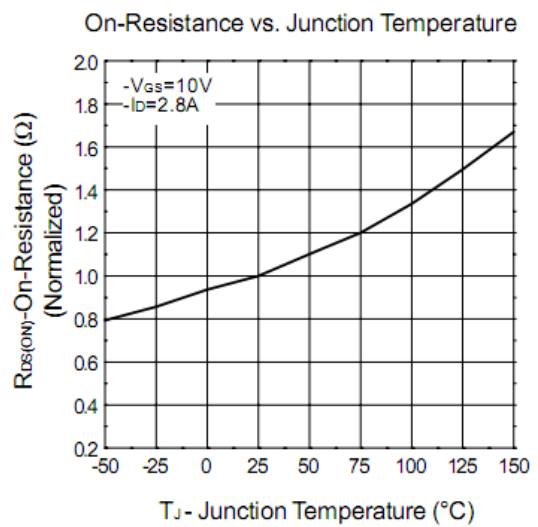
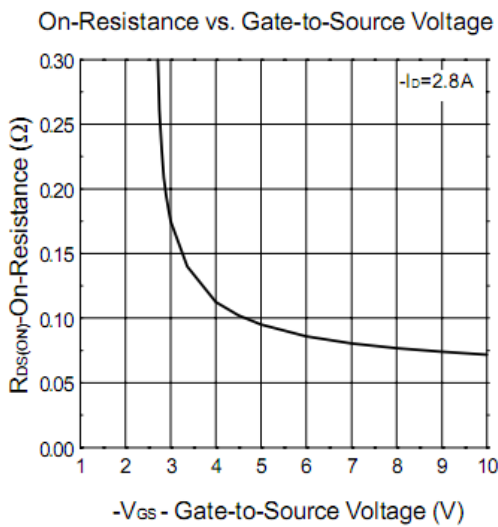
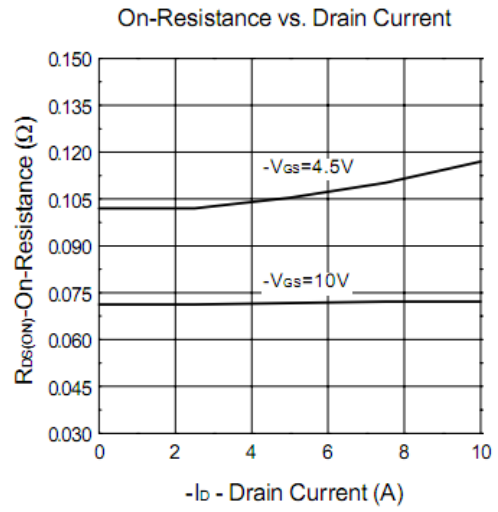
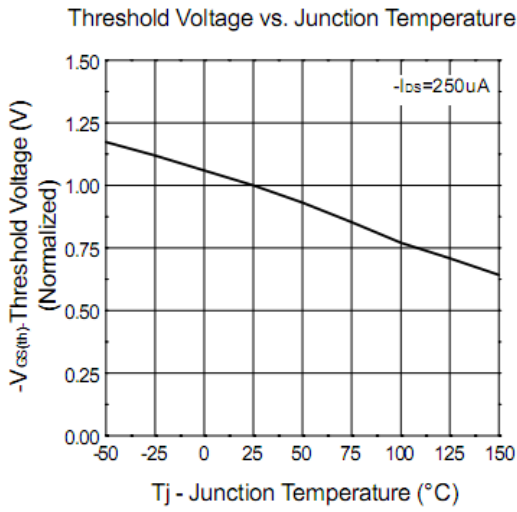
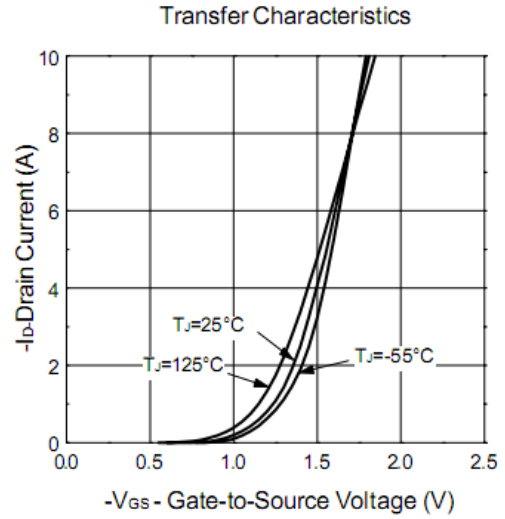
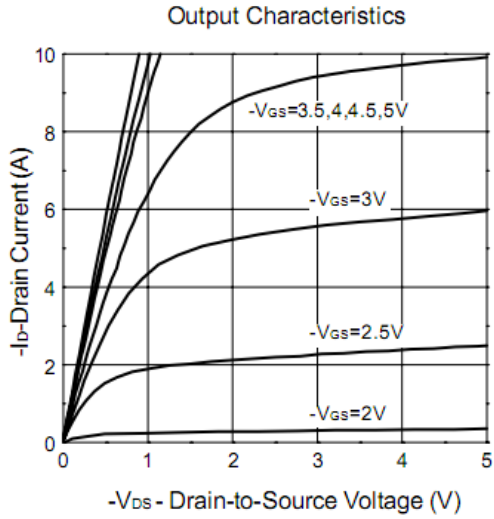

Typical Characteristics

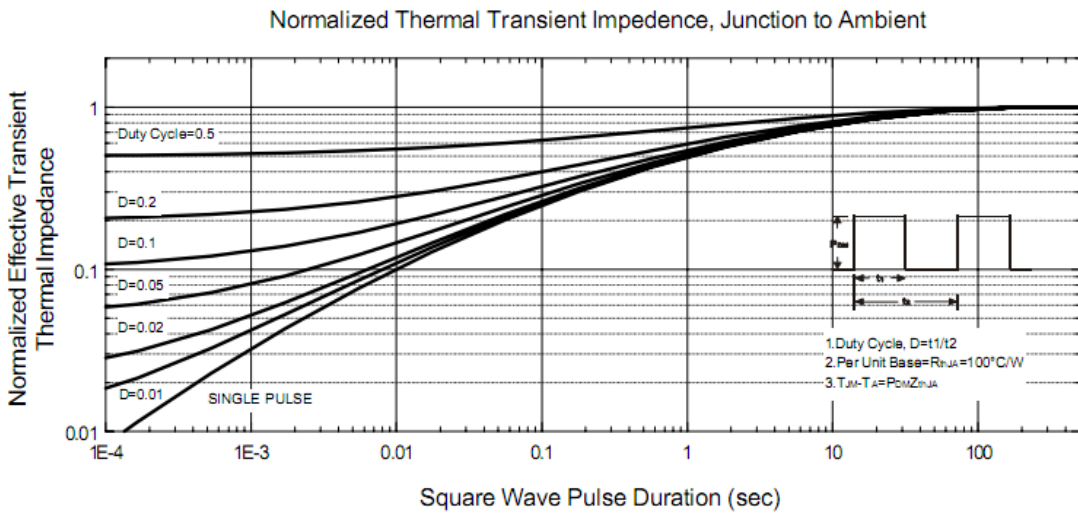
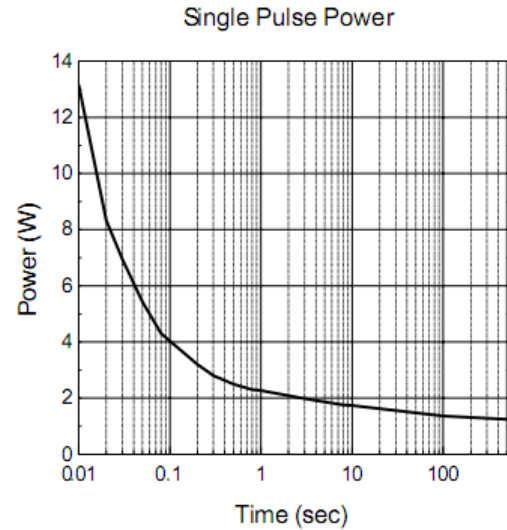
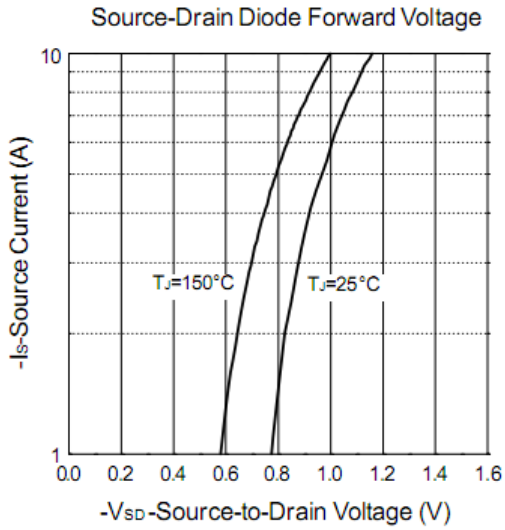
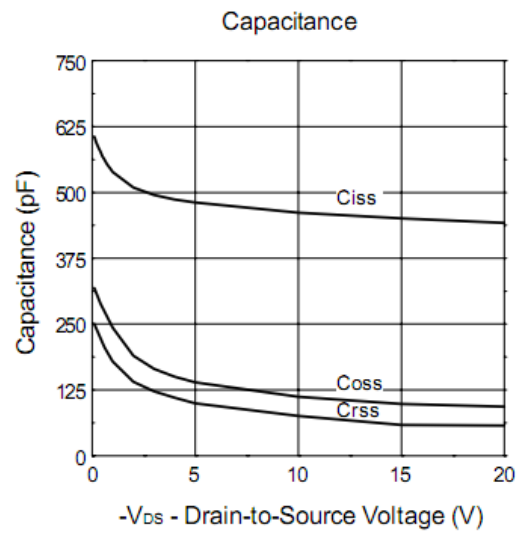
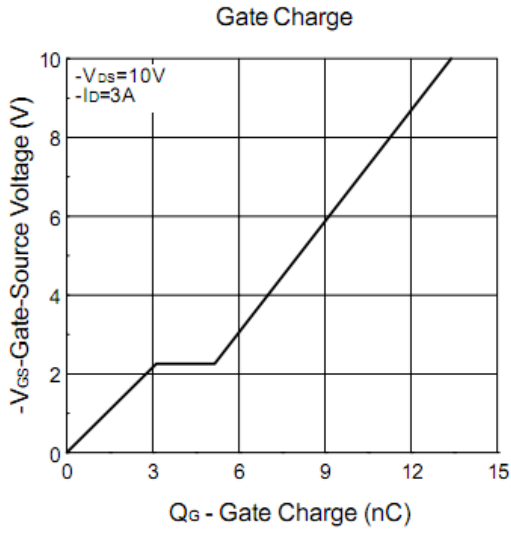

Packaging Information(SOT323)

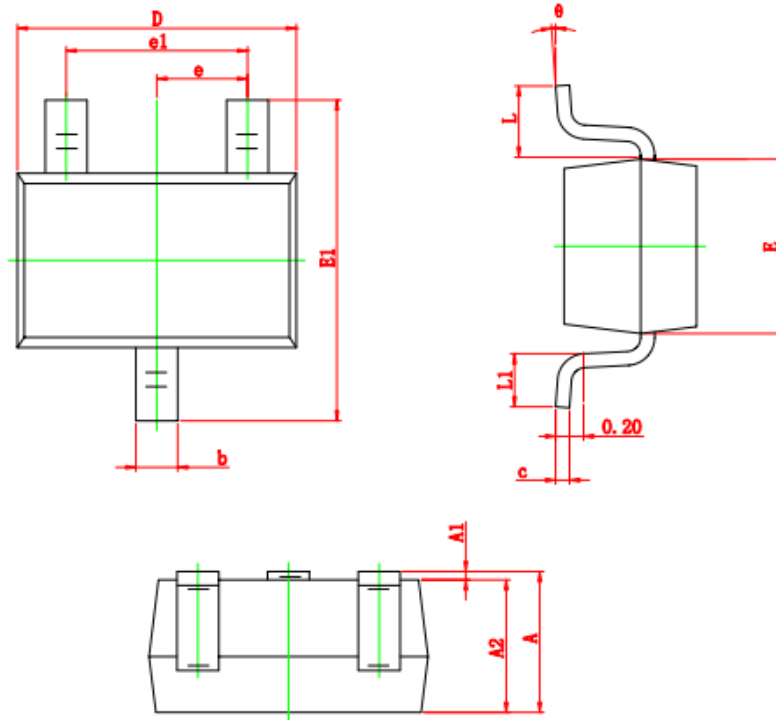

Symbol	Dimensions In Millimeters		Dimensions In Inches	
	Min	Max	Min	Max
A	0.900	1.100	0.035	0.043
A1	0.000	0.100	0.000	0.004
A2	0.900	1.000	0.035	0.039
b	0.200	0.400	0.008	0.016
c	0.080	0.150	0.003	0.006
D	2.000	2.200	0.079	0.087
E	1.150	1.350	0.045	0.053
E1	2.150	2.450	0.085	0.096
e	0.650 TYP		0.026 TYP	
e1	1.200	1.400	0.047	0.055
L	0.525 REF		0.021 REF	
L1	0.260	0.460	0.010	0.018
θ	0°	8°	0°	8°

The SINO-IC logo is a registered trademark of ShangHai Sino-IC Microelectronics Co., Ltd.
© 2005 SINO-IC – Printed in China – All rights reserved.

SHANGHAI SINO-IC MICROELECTRONICS CO., LTD

Add: Building 3, Room 3401-03, No.200 Zhangheng Road, ZhangJiang Hi-Tech Park, Pudong,
Shanghai 201203, China

Phone: +86-21-33932402 33932403 33932405 33933508 33933608

Fax: +86-21-33932401

Email: webmaster@sino-ic.com

Website: <http://www.sino-ic.com>