

SE4946
Dual N-Channel Enhancement-Mode MOSFET

Revision:A

General Description

The MOSFETs from SINO-IC provide the best combination of fast switching, low on-resistance and cost-effectiveness.

Features

- V_{DS} (V) = 60V
- I_D = 6.5A (V_{GS} = 10V)
- $R_{DS(ON)}$ = 41m Ω (V_{GS} = 10V)
- $R_{DS(ON)}$ = 52m Ω (V_{GS} = 4.5V)

Pin configurations

See Diagram below

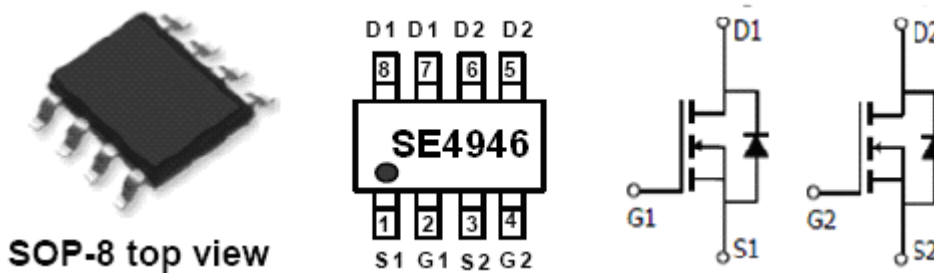

Absolute Maximum Ratings

Parameter		Symbol	Rating	Units
Drain-Source Voltage		VDS	60	V
Gate-Source Voltage		VGS	±20	V
Drain Current (Note 1)	Continuous	ID	6.5	A
	Pulsed		30	
Total Power Dissipation		PD	2	mW
Operating Junction Temperature Range		TJ	-55 to 150	°C

Thermal Characteristics

Parameter		Symbol	Typ	Max	Units
Maximum Junction-to-Ambient A	$t \leq 10s$	$R_{\theta JA}$	50	62.2	°C/W
	Steady-State		73	110	
Maximum Junction-to-Lead C	Steady-State	$R_{\theta JL}$	31	40	°C/W

Electrical Characteristics (T _J =25°C unless otherwise noted)						
Symbol	Parameter	Test Conditions	Min	Typ	Max	Units
OFF/ON CHARACTERISTICS (Note 2)						
BVDSS	Drain-Source Breakdown Voltage	ID=250 μ A, VGS=0 V	60			V
IDSS	Zero Gate Voltage Drain Current	VDS=48 V, VGS=0 V			1	μ A
IGSS	Gate-Body leakage current	VDS=0 V, VGS=±20 V			±100	μ A
VGS(th)	Gate Threshold Voltage	VDS=VGS ID=250 μ A	1	2.1	3	V
RDS(ON)	Static Drain-Source On-Resistance ²	VGS=10V, ID=5.3 A	-	33	41	mΩ
		VGS=4.5V, ID=4.7A	-	41	52	
gFS	Forward Transconductance	VDS=5V, ID=6.3A	-	24	-	S
DYNAMIC PARAMETERS						
Ciss	Input Capacitance	VGS=0V, VDS=30V, f=1MHz	-	1920	2300	pF
Coss	Output Capacitance		-	155	-	pF
Crss	Reverse Transfer Capacitance		-	116	-	pF
TON	Turn-On Time	VDS =30V, RL= 4.7 Ω VGS = 10 V, RGEN = 3 Ω	-	7.6	-	ns
TOFF	Turn-Off Time		-	5	-	ns
Tr	Turn-on Rise Time		-	28.9	-	ns
Tf	Turn-on Fall Time		-	5.5	-	ns
Qg(10)	Total Gate Charge	VDS=15V, ID=6.3A, VGS=10 V		47.6	58	nC
Qgs	Gate-Source Charge			6		nC
Qgd	Gate-Drain Charge			14.4		nC
trr	Body Diode Reverse Recovery Time	IF=6.3A, dI/dt=100A/ μ s		33.2	40	nS
Qrr	Body Diode Reverse Recovery Charge	IF=6.3A, dI/dt=100A/ μ s		43		Nc

Typical Characteristics

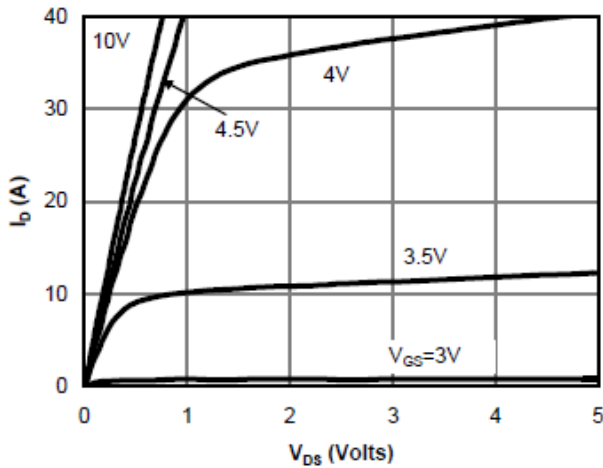

Fig 1: On-Region Characteristics

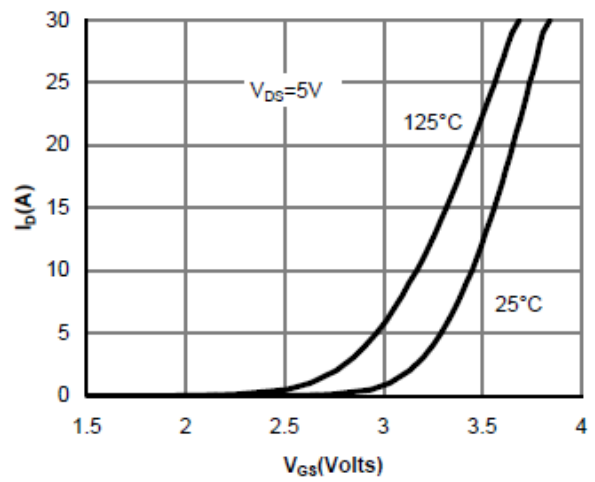

Figure 2: Transfer Characteristics

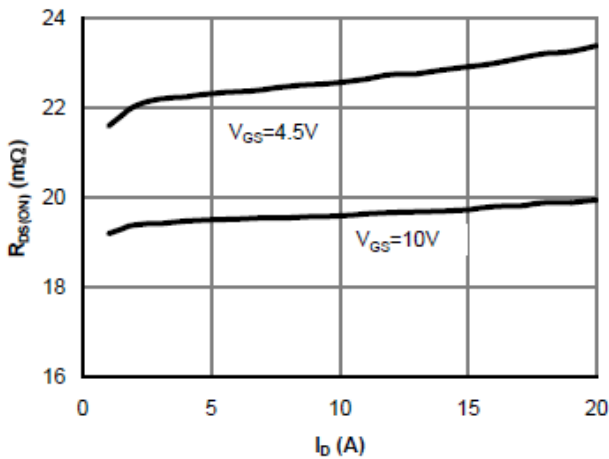

Figure 3: On-Resistance vs. Drain Current and Gate Voltage

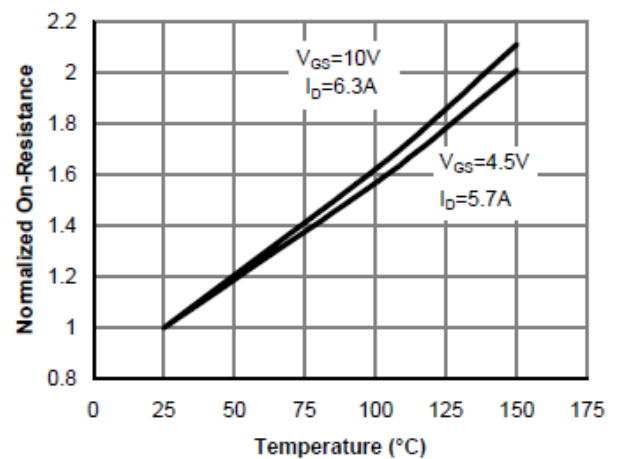

Figure 4: On-Resistance vs. Junction Temperature

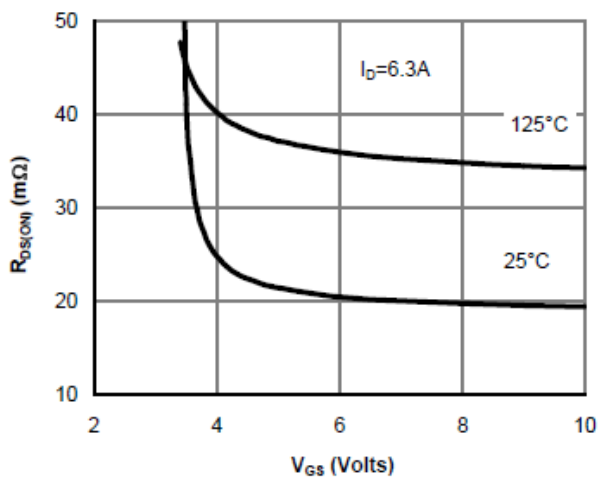

Figure 5: On-Resistance vs. Gate-Source Voltage

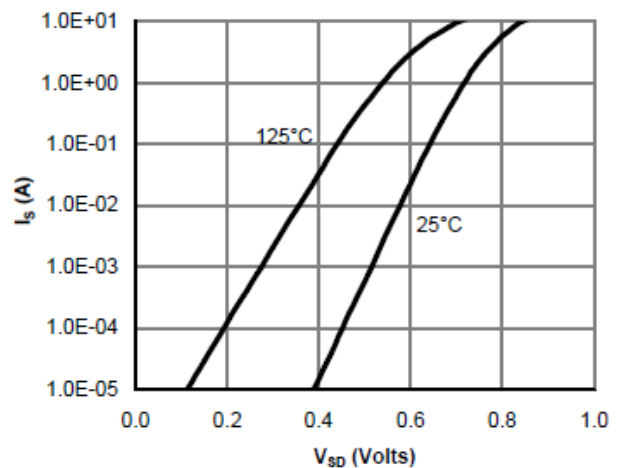

Figure 6: Body-Diode Characteristics

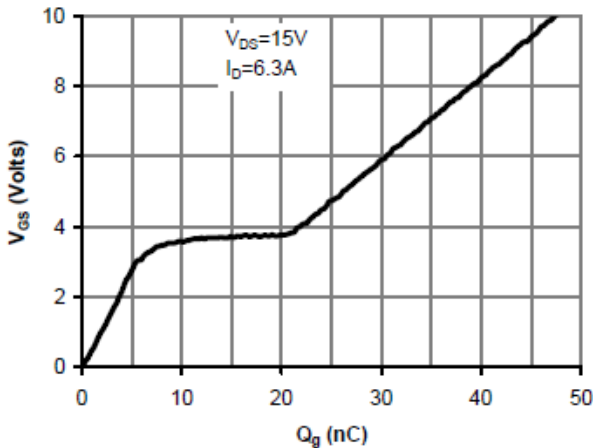

Figure 7: Gate-Charge Characteristics

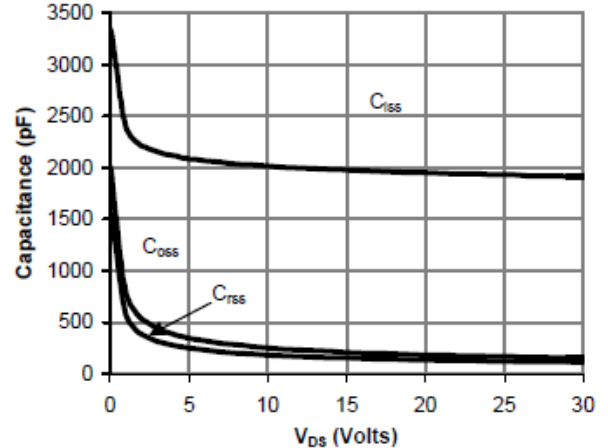

Figure 8: Capacitance Characteristics

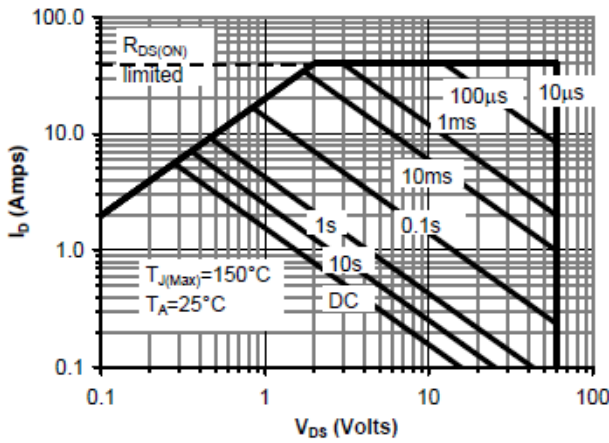

Figure 9: Maximum Forward Biased Safe Operating Area (Note E)

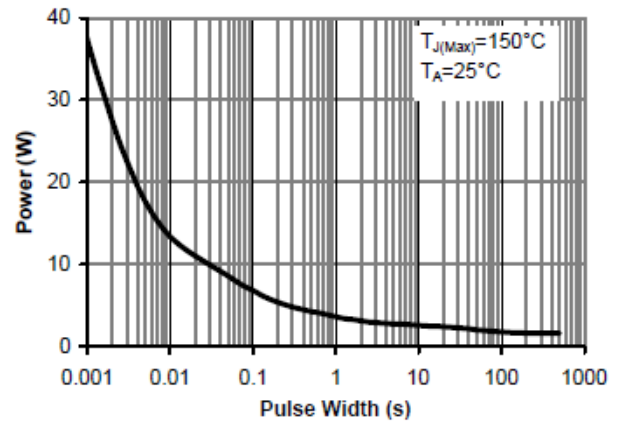

Figure 10: Single Pulse Power Rating Junction-to-Ambient (Note E)

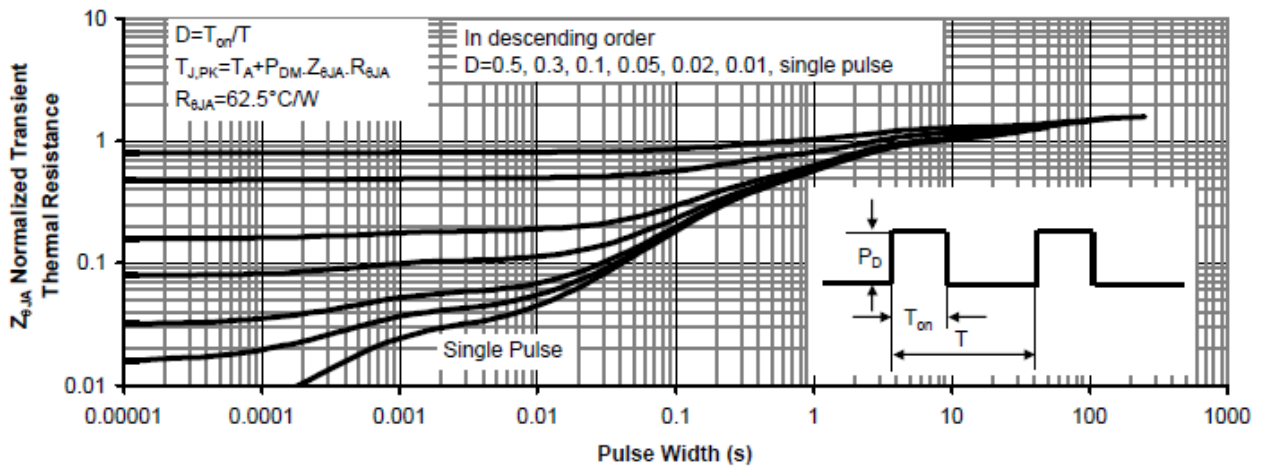
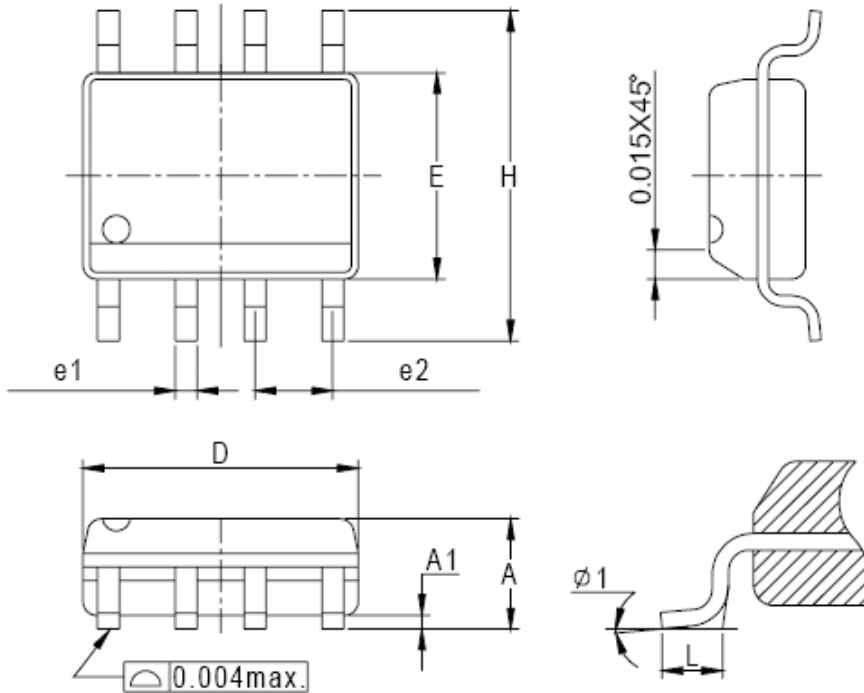

Figure 11: Normalized Maximum Transient Thermal Impedance

SE4946

Packaging Information

SOP-8 pin



Dim	Millimeters		Inches	
	Min.	Max.	Min.	Max.
A	1.35	1.75	0.053	0.069
A1	0.10	0.25	0.004	0.010
D	4.80	5.00	0.189	0.197
E	3.80	4.00	0.150	0.157
H	5.80	6.20	0.228	0.244
L	0.40	1.27	0.016	0.050
e1	0.33	0.51	0.013	0.020
e2	1.27BSC		0.50BSC	
φ 1	8°		8°	

The SINO-IC logo is a registered trademark of ShangHai Sino-IC Microelectronics Co., Ltd.

© 2005 SINO-IC – Printed in China – All rights reserved.

SHANGHAI SINO-IC MICROELECTRONICS CO., LTD

Add: Building 3, Room 3401-03, No.200 Zhangheng Road, ZhangJiang Hi-Tech Park, Pudong, Shanghai 201203, China

Phone: +86-21-33932402 33932403 33932405 33933508 33933608

Fax: +86-21-33932401

Email: webmaster@sino-ic.com

Website: <http://www.sino-ic.com>