

SE2N7002E
60V,300mA N-Channel MOSFET

Revision:A

General Description

The MOSFETs from SINO-IC provide the best combination of fast switching, low on-resistance and cost-effectiveness.

Features

- $V_{DS(V)} = 60V$
- $I_D = 300mA$
- $R_{DS(ON)} < 2\Omega$ ($V_{GS} = 10V, I_D=0.5A$)
- $R_{DS(ON)} < 3\Omega$ ($V_{GS} = 5V, I_D=0.05A$)

Pin configurations

See Diagram below

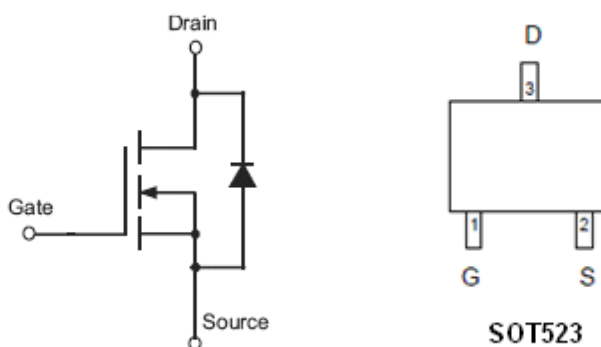

Absolute Maximum Ratings

Parameter		Symbol	Rating	Units
Drain-Source Voltage		V_{DS}	60	V
Gate-Source Voltage		V_{GS}	± 20	V
Drain Current (Note 1)	Continuous	I_D	300	mA
	Pulsed		800	
Total Power Dissipation		P_D	350	mW
Operating Junction Temperature Range		T_J	-55 to 150	$^{\circ}C$

Thermal Characteristics

Parameter		Symbol	Typ	Max	Units
Maximum Junction-to-Ambient A	$t \leq 5s$	$R_{\theta JA}$	357	-	$^{\circ}C/W$

Electrical Characteristics (T_J=25°C unless otherwise noted)

Symbol	Parameter	Test Conditions	Min	Typ	Max	Units
OFF/ON CHARACTERISTICS (Note 2)						
BV _{DSS}	Drain-Source Breakdown Voltage	I _D =10 μA, V _{GS} =0V	60			V
I _{DSS}	Zero Gate Voltage Drain Current	V _{DS} =60V, V _{GS} =0V			1	μA
I _{GSS}	Gate-Body leakage current	V _{DS} =0V, V _{GS} =±20V			±10	μA
V _{GS(th)}	Gate Threshold Voltage	V _{DS} =V _{GS} I _D =250uA	1		2.5	V
R _{DS(ON)}	Static Drain-Source On-Resistance2	V _{GS} =10V, I _D =0.5A		2	-	Ω
		V _{GS} =5V, I _D =0.05A		3	-	Ω
Y _{fs}	Forward Transfer Admittance	V _{GS} = 10 V, I _S = 0.2 A	80			ms
DYNAMIC PARAMETERS						
C _{iss}	Input Capacitance	V _{GS} =0V, V _{DS} =25V, f=1MHz			50	pF
C _{oss}	Output Capacitance				25	pF
C _{rss}	Reverse Transfer Capacitance				5	pF

Typical Characteristics

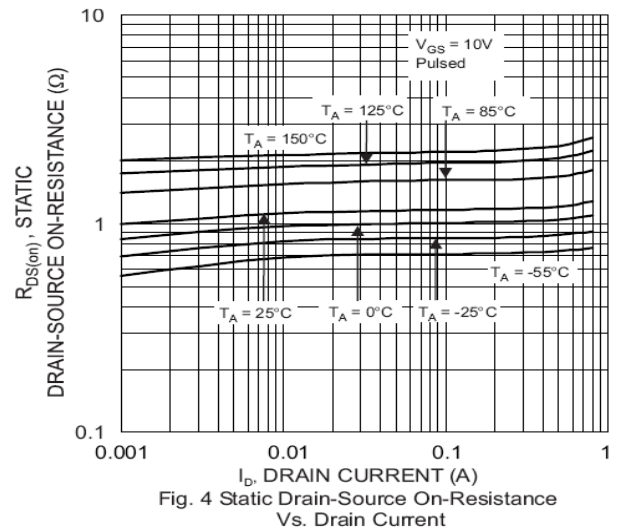
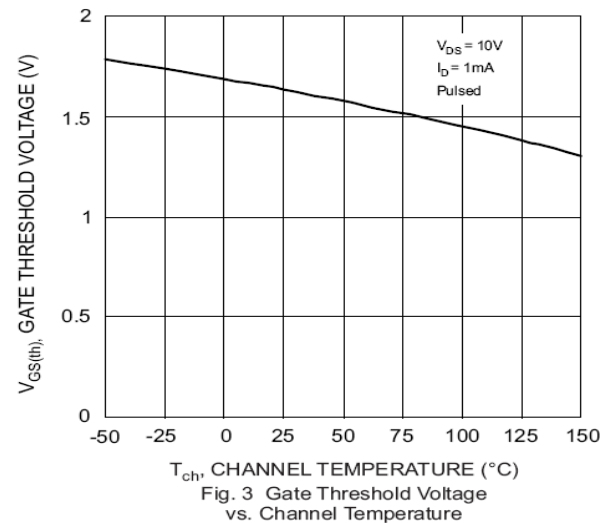
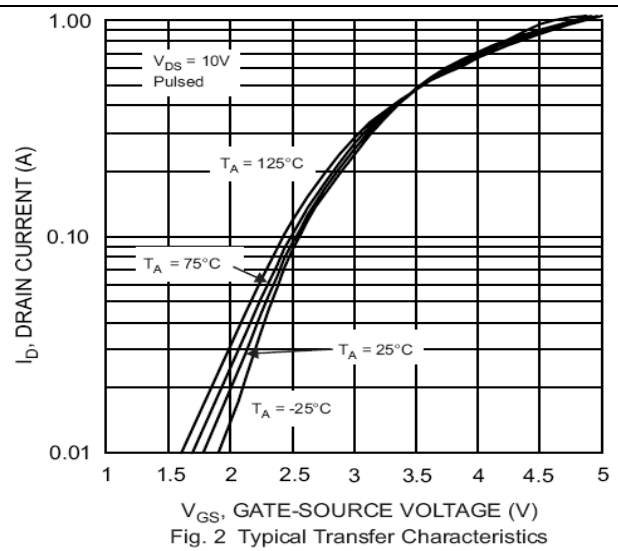
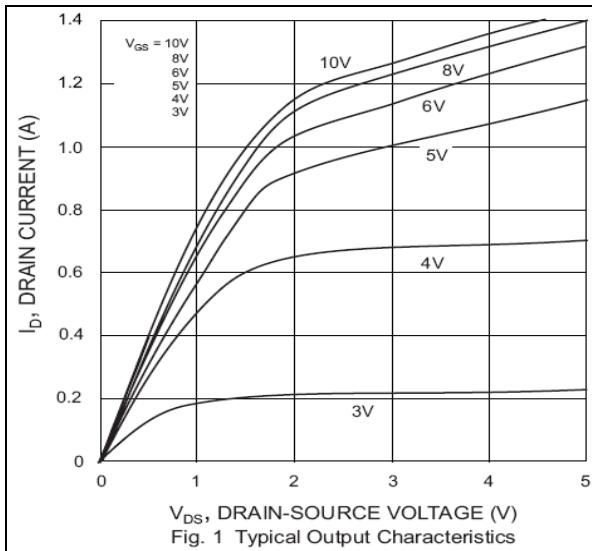

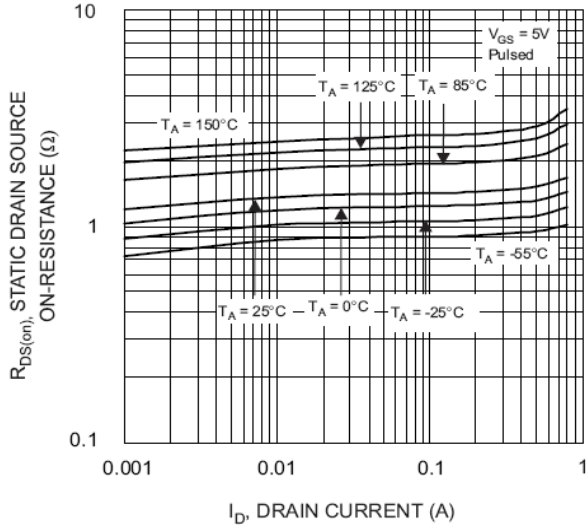

Fig. 5 Static Drain-Source On-Resistance vs. Drain Current

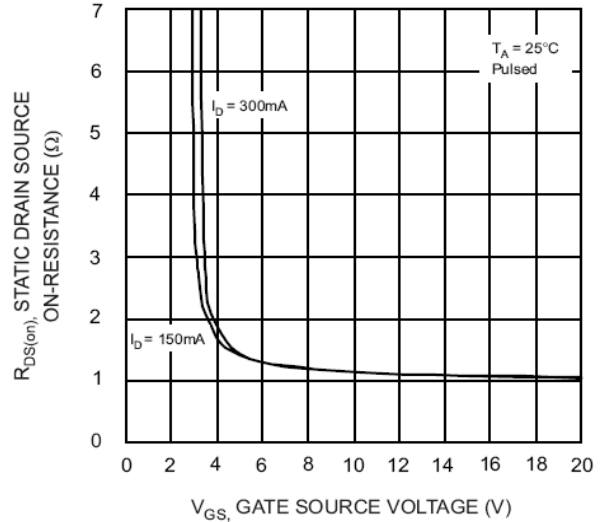

Fig. 6 Static Drain-Source On-Resistance vs. Gate-Source Voltage

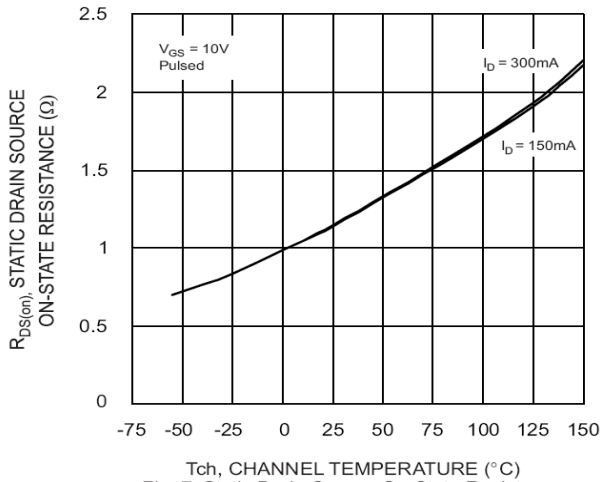

Fig. 7 Static Drain-Source On-State Resistance vs. Channel Temperature

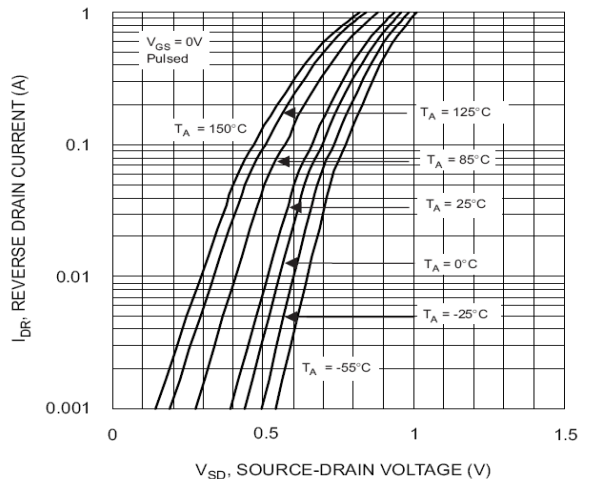

Fig. 8 Reverse Drain Current vs. Source-Drain Voltage

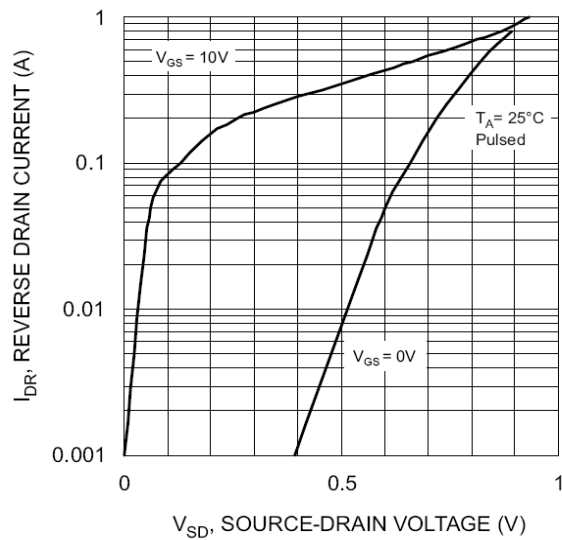

Fig. 9 Reverse Drain Current vs. Source-Drain Voltage

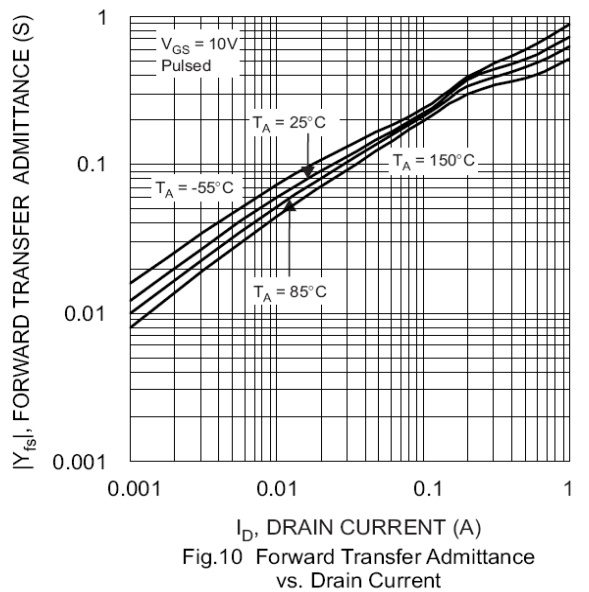
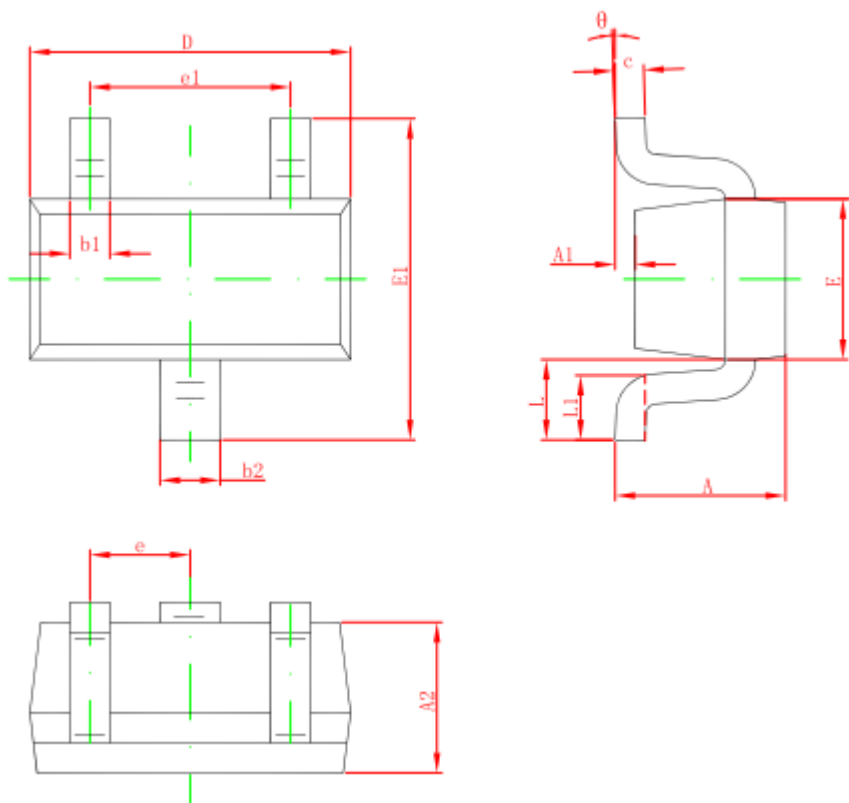

Fig. 10 Forward Transfer Admittance vs. Drain Current

SE2N7002E

SOT-523 PACKAGE OUTLINE DIMENSIONS



Symbol	Dimensions In Millimeters		Dimensions In Inches	
	Min.	Max.	Min.	Max.
A	0.700	0.900	0.028	0.035
A1	0.000	0.100	0.000	0.004
A2	0.700	0.800	0.028	0.031
b1	0.150	0.250	0.006	0.010
b2	0.250	0.350	0.010	0.014
c	0.100	0.200	0.004	0.008
D	1.500	1.700	0.059	0.067
E	0.700	0.900	0.028	0.035
E1	1.450	1.750	0.057	0.069
e	0.500 TYP.		0.020 TYP.	
e1	0.900	1.100	0.035	0.043
L	0.400 REF.		0.016 REF.	
L1	0.260	0.460	0.010	0.018
θ	0°	8°	0°	8°

The SINO-IC logo is a registered trademark of ShangHai Sino-IC Microelectronics Co., Ltd.

© 2005 SINO-IC – Printed in China – All rights reserved.

SHANGHAI SINO-IC MICROELECTRONICS CO., LTD

Add: Building 3, Room 3401-03, No.200 Zhangheng Road, ZhangJiang Hi-Tech Park, Pudong, Shanghai 201203, China

Phone: +86-21-33932402 33932403 33932405 33933508 33933608

Fax: +86-21-33932401

Email: webmaster@sino-ic.com

Website: <http://www.sino-ic.com>