

**SE2302U**  
**2.4A,20V N-Channel MOSFET**

Revision:A

**General Description**

The MOSFETs from SINO-IC provide the best combination of fast switching, low on-resistance and cost-effectiveness.

**Features**

- $V_{DS}$  (V) = 20V
- $I_D$  = 2.4A
- $R_{DS(ON)} < 60m\Omega$  ( $V_{GS} = 4.5V$ )

**Pin configurations**

See Diagram below

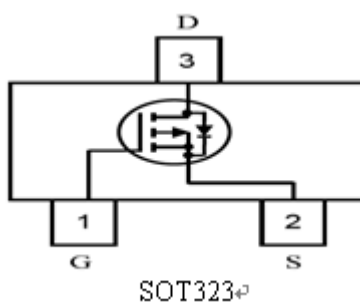

**Absolute Maximum Ratings**

Parameter		Symbol	Rating	Units
Drain-Source Voltage		$V_{DS}$	20	V
Gate-Source Voltage		$V_{GS}$	$\pm 8$	V
Drain Current (Note 1)	Continuous	$I_D$	2.4	A
	Pulsed		9	
Total Power Dissipation		$P_D$	1.25	W
Operating Junction Temperature Range		$T_J$	-50 to 150	$^{\circ}C$

**Thermal Characteristics**

Parameter		Symbol	Typ	Max	Units
Maximum Junction-to-Ambient $\theta_{JA}$	$t \leq 10s$	$\theta_{JA}$	-	100	$^{\circ}C/W$

Electrical Characteristics (T <sub>J</sub> =25°C unless otherwise noted)						
Symbol	Parameter	Test Conditions	Min	Typ	Max	Units
<b>OFF/ON CHARACTERISTICS (Note 2)</b>						
BV <sub>DSS</sub>	Drain-Source Breakdown Voltage	I <sub>D</sub> =250 μ A, V <sub>GS</sub> =0 V	20			V
I <sub>DSS</sub>	Zero Gate Voltage Drain Current	V <sub>DS</sub> =20 V, V <sub>GS</sub> =0 V			1	μ A
I <sub>GSS</sub>	Gate-Body leakage current	V <sub>DS</sub> =0 V, V <sub>GS</sub> =±8 V			100	nA
V <sub>GS(th)</sub>	Gate Threshold Voltage	V <sub>DS</sub> =V <sub>GS</sub> I <sub>D</sub> =250 μ A	0.6	-	1.2	V
R <sub>DS(ON)</sub>	Static Drain-Source On-Resistance <sup>2</sup>	V <sub>GS</sub> =4.5V, I <sub>D</sub> =2.8A	-	43	60	mΩ
		V <sub>GS</sub> =2.5V, I <sub>D</sub> =2.0A		52	115	mΩ
		V <sub>GS</sub> =1.8V, I <sub>D</sub> =2.0A		80	130	mΩ
<b>DYNAMIC PARAMETERS</b>						
C <sub>iss</sub>	Input Capacitance	V <sub>GS</sub> =0V, V <sub>DS</sub> =10V, f=1MHz		450		pF
C <sub>oss</sub>	Output Capacitance			70		pF
C <sub>rss</sub>	Reverse Transfer Capacitance			43		pF
TON	Turn-On Time	V <sub>DS</sub> =10V, I <sub>D</sub> = 1A, V <sub>GS</sub> =4.5 V, R <sub>GEN</sub> =6 Ω	-	7	15	ns
TOFF	Turn-Off Time		-	16	60	ns
Tr	Turn-on Rise Time		-	55	80	ns
Tf	Turn-on Fall Time		-	20	25	ns
Q <sub>g(10)</sub>	Total Gate Charge	V <sub>DS</sub> =10V, I <sub>D</sub> =3.6A, V <sub>GS</sub> =4.5V		5.2	10	nC
Q <sub>gs</sub>	Gate-Source Charge			0.65	.	nC
Q <sub>gd</sub>	Gate-Drain Charge			1.5		nC
V <sub>SD</sub>	Drain-Source Diode Forward Voltage	V <sub>GS</sub> =0 V, I <sub>S</sub> =1.0 A		0.76	1.2	V
I <sub>S</sub>	Maximum Continuous Drain-Source Diode Forward Current				1.6	A

# Typical Characteristics

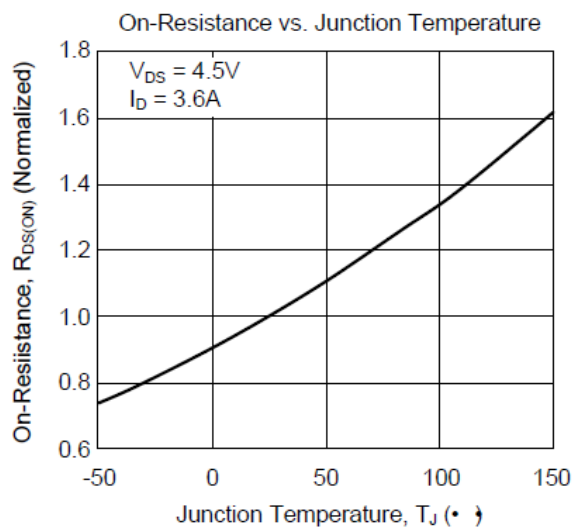
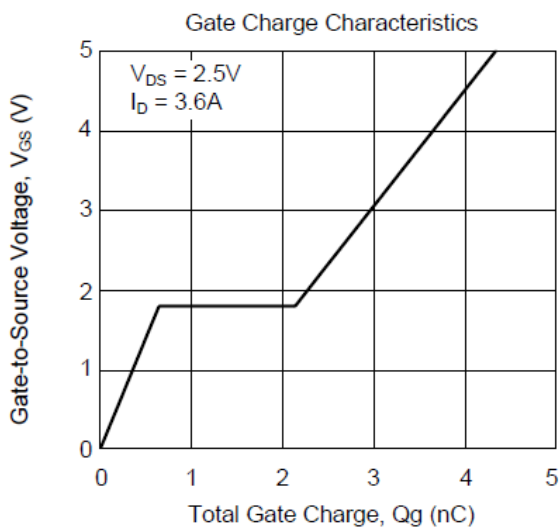
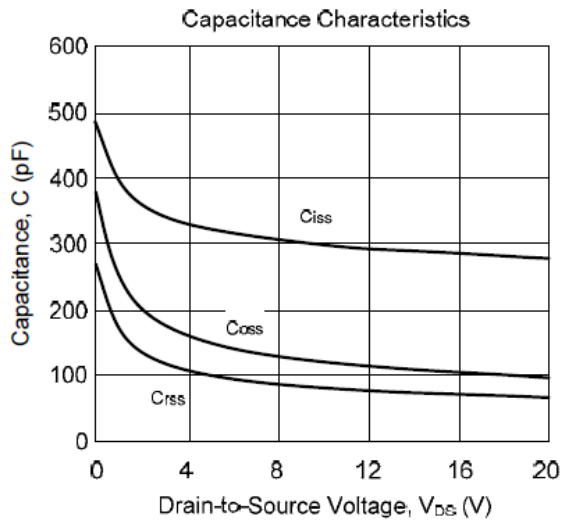
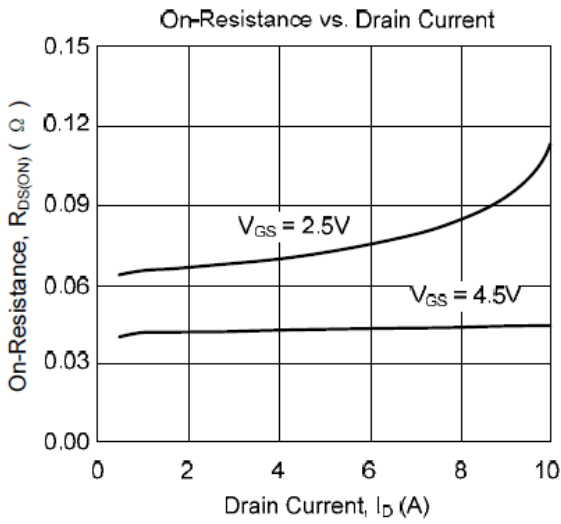
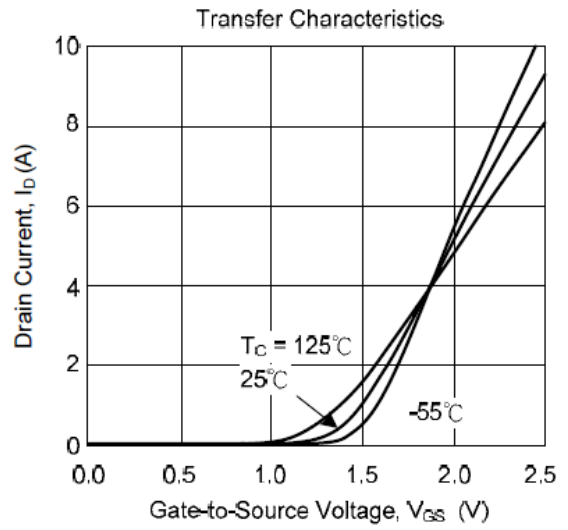
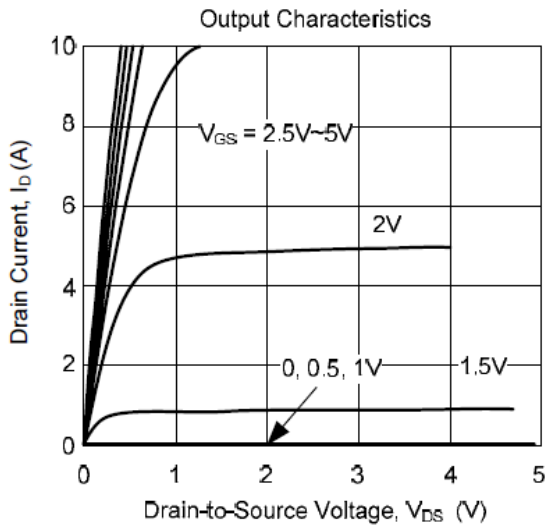

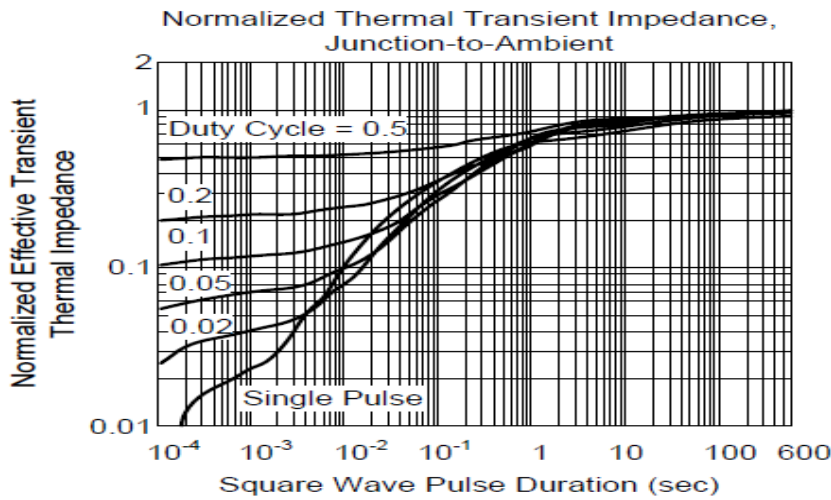
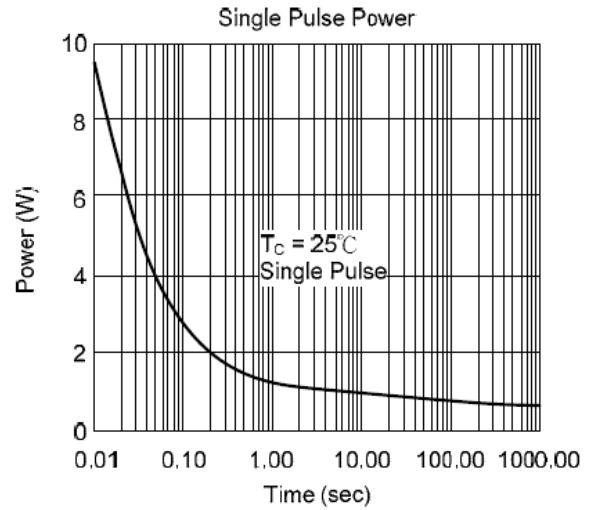
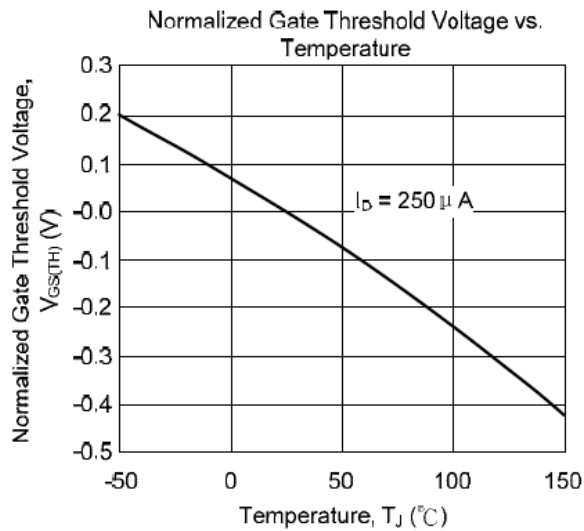
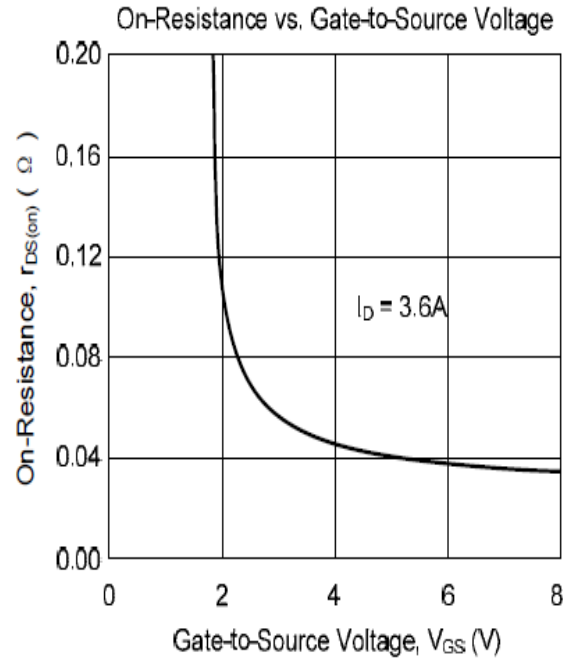
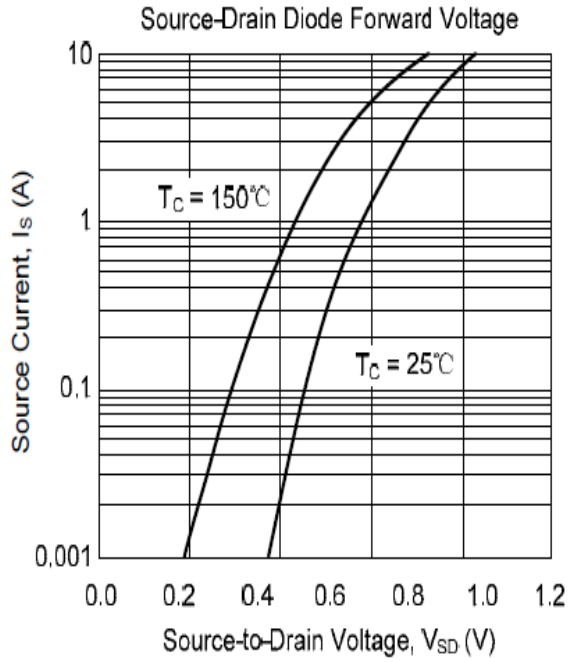

## Packaging Information(SOT323)

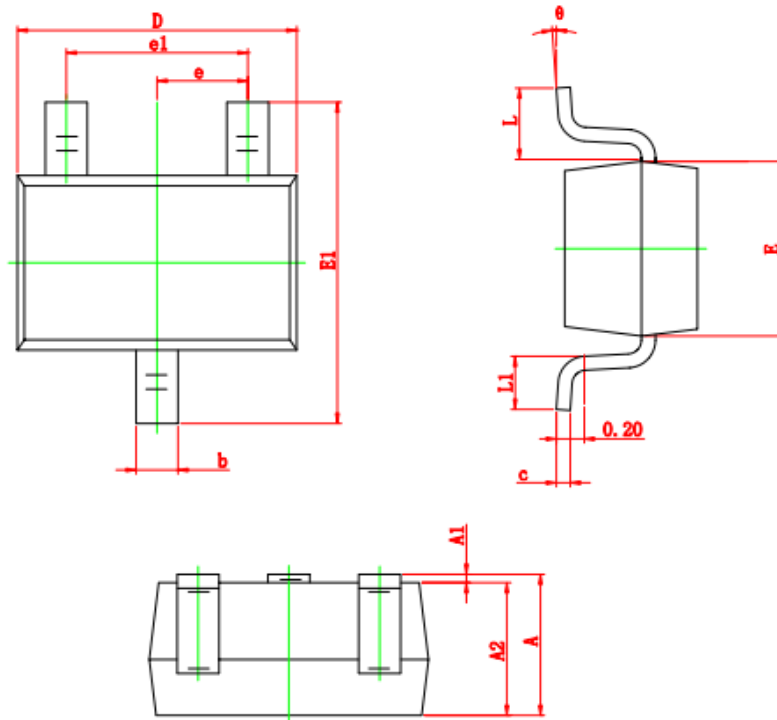

Symbol	Dimensions In Millimeters		Dimensions In Inches	
	Min	Max	Min	Max
A	0.900	1.100	0.035	0.043
A1	0.000	0.100	0.000	0.004
A2	0.900	1.000	0.035	0.039
b	0.200	0.400	0.008	0.016
c	0.080	0.150	0.003	0.006
D	2.000	2.200	0.079	0.087
E	1.150	1.350	0.045	0.053
E1	2.150	2.450	0.085	0.096
e	0.650 TYP		0.026 TYP	
e1	1.200	1.400	0.047	0.055
L	0.525 REF		0.021 REF	
L1	0.260	0.460	0.010	0.018
θ	0°	8°	0°	8°

The SINO-IC logo is a registered trademark of ShangHai Sino-IC Microelectronics Co., Ltd.  
© 2005 SINO-IC – Printed in China – All rights reserved.

**SHANGHAI SINO-IC MICROELECTRONICS CO., LTD**

**Add:** Building 3, Room 3401-03, No.200 Zhangheng Road, ZhangJiang Hi-Tech Park, Pudong,  
Shanghai 201203, China

**Phone:** +86-21-33932402 33932403 33932405 33933508 33933608

**Fax:** +86-21-33932401

**Email:** [webmaster@sino-ic.com](mailto:webmaster@sino-ic.com)

**Website:** <http://www.sino-ic.com>