

SE4606L

Complementary Enhancement Mode Field Effect Transistor

Revision:A

Features

- n-channel,
 $V_{DS} (V) = 20V$, $I_D = 7A$
 $R_{DS(ON)} = 20.0m\Omega$ ($V_{GS} = 4.5V$)
- p-channel,
 $V_{DS} (V) = -18V$, $I_D = -5A$
 $R_{DS(ON)} = 30m\Omega$ ($V_{GS} = -4.5V$)

External Dimensions: (Unit:mm)

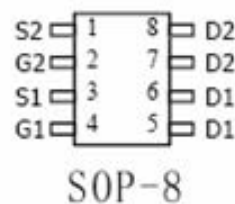

Applications

- Power Management in Desktop or DC/DC Converters

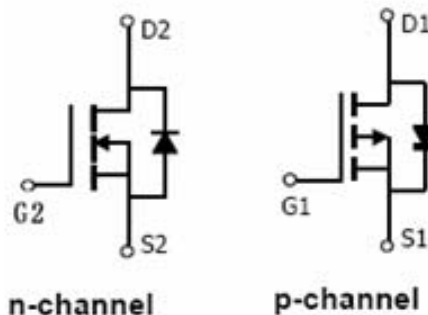

Construction

- Silicon epitaxial planer

Absolute maximum ratings (Ta=25°C)

Parameter	Symbol	Max n-channel	Max P-channel	Unit	
Drain-Source Voltage	V_{DS}	20	-18	V	
Gate-Source Voltage	V_{GSS}	±8	±8	V	
Drain Current-Continuous@ Current-Pulsed (Note 1)	I_D	TA=25°C	7.0	-5	A
		TA=70°C	7.4	-4	
	I_{DM}	50	-30	A	
Maximum Power Dissipation	P_D	3	2	W	
Operating Junction and Storage Temperature Range	T_J, T_{STG}	-55 To 150	-55 To 150	°C	

THERMAL CHARACTERISTICS

Thermal Resistance, Junction-to-Ambient (Note 2)	$R_{\theta JA}$	62.5	62.5	°C/W
--	-----------------	------	------	------

N-Channel Electrical Characteristics (TJ=25°C unless otherwise noted)

Parameter	Symbol	Conditions	Min.	Typ.	Max.	Unit
OFF CHARACTERISTICS						
Drain-Source Breakdown Voltage	BV_{DSS}	$V_{GS} = 0V, I_D = 250\mu A$	20			V

SE4606L

Zero Gate Voltage Drain Current	I_{DSS}	$V_{DS} = 24V, V_{GS} = 0V$			1	μA
Gate-Body Leakage Current	I_{GSS}	$V_{GS} = \pm 20V, V_{DS} = 0V$			± 100	nA
ON CHARACTERISTICS (Note 3)						
Gate Threshold Voltage	$V_{GS(th)}$	$V_{DS} = V_{GS}, I_D = 250\mu A$		0.65		V
Drain-Source On-State Resistance	$R_{DS(on)}$	$V_{GS} = 4.5V, I_D = 4.5A$		20	23.5	m Ω
		$V_{GS} = 2.5V, I_D = -4.1A$		25	32	m Ω
Forward Transconductance	g_{FS}	$V_{DS} = 5V, I_D = 5A$	10	17		S
DYNAMIC CHARACTERISTICS (Note4)						
Input Capacitance	C_{iss}	$V_{DS} = 15V, V_{GS} = 0V,$ $F = 1.0MHz$		680		PF
Output Capacitance	C_{oss}			102		PF
Reverse Transfer Capacitance	C_{rss}			77		PF
SWITCHING CHARACTERISTICS (Note 4)						
Turn-on Delay Time	$t_{d(on)}$	$V_{DS} = 15V, V_{GS} = 10V,$ $R_{GEN} = 3\Omega, R_L = 2.2\Omega$		4.6		nS
Turn-on Rise Time	t_r			4.1		nS
Turn-Off Delay Time	$t_{d(off)}$			20.6		nS
Turn-Off Fall Time	t_f			5.2		nS
Total Gate Charge	Q_g	$V_{DS} = 15V, I_D = 6.9A,$ $V_{GS} = 10V$		13.8		nC
Gate-Source Charge	Q_{gs}			1.8		nC
Gate-Drain Charge	Q_{gd}			3.3		nC
DRAIN-SOURCE DIODE CHARACTERISTICS						
Diode Forward Voltage (Note 3)	V_{SD}	$I_{SD} = 1A$		0.76	1	V
P-Channel Electrical Characteristics (T _J =25°C unless otherwise noted)						
Parameter	Symbol	Conditions	Min.	Typ.	Max.	Unit
OFF CHARACTERISTICS						
Drain-Source Breakdown Voltage	BV_{DSS}	$V_{GS} = 0V, I_D = -250\mu A$	-15			V

SE4606L

Zero Gate Voltage Drain Current	I_{DSS}	$V_{DS} = -12V, V_{GS} = 0V$			-1	μA
Gate-Body Leakage Current	I_{GSS}	$V_{GS} = \pm 8V, V_{DS} = 0V$			± 100	nA
ON CHARACTERISTICS (Note 3)						
Gate Threshold Voltage	$V_{GS(th)}$	$V_{DS} = V_{GS}, I_D = -250\mu A$.	-0.65		V
Drain-Source On-State Resistance	$R_{DS(on)}$	$V_{GS} = -4.5V, I_D = -4.9A$		31	42	m Ω
		$V_{GS} = -2.5V, I_D = -5A$		36	56	m Ω
Forward Transconductance	g_{FS}	$V_{DS} = -12V, I_D = -4.5A$	5	10		S
DYNAMIC CHARACTERISTICS (Note4)						
Turn-on Delay Time	$t_{d(on)}$	$V_{DS} = -12V,$ $V_{GS} = -10V,$ $R_{GEN} = 3\Omega, R_L = 2.7\Omega$		12		nS
Turn-on Rise Time	t_r			3		nS
Turn-Off Delay Time	$t_{d(off)}$			22		nS
Turn-Off Fall Time	t_f			4		nS
Total Gate Charge	Q_g	$V_{DS} = -12V, I_{DS} = -6A,$ $V_{GS} = -10V$		10		nC
Gate-Source Charge	Q_{gs}			3.3		nC
Gate-Drain Charge	Q_{gd}			1.8		nC
DRAIN-SOURCE DIODE CHARACTERISTICS						
Diode Forward Voltage (Note 3)	V_{SD}	$I_{SD} = -1.7A$		-0.8	-1.2	V

N-CHANNEL TYPICAL ELECTRICAL AND THERMAL CHARACTERISTICS

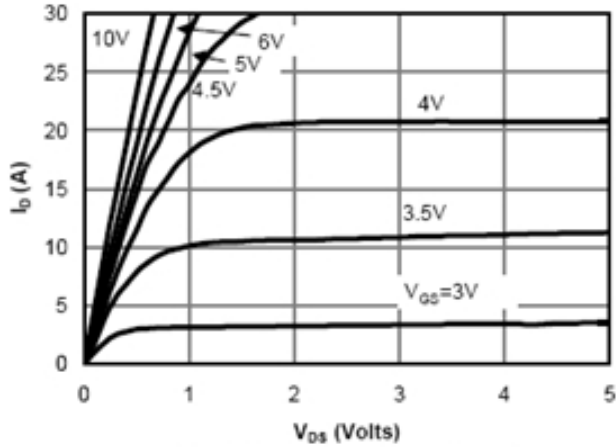

Fig 1: On-Region Characteristics

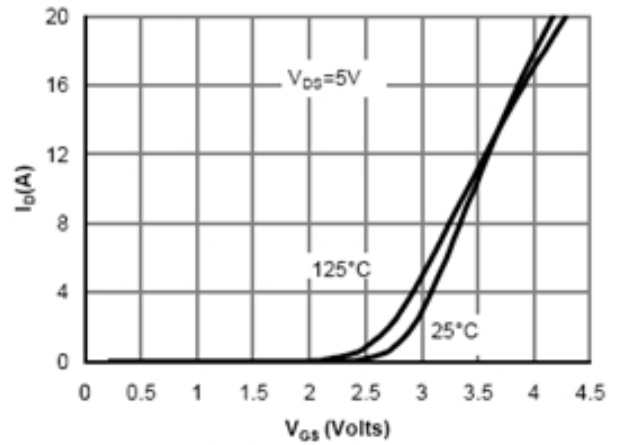

Figure 2: Transfer Characteristics

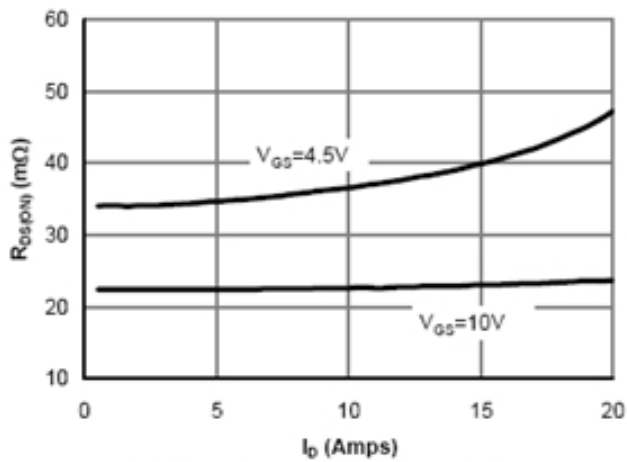

Figure 3: On-Resistance vs. Drain Current and Gate Voltage

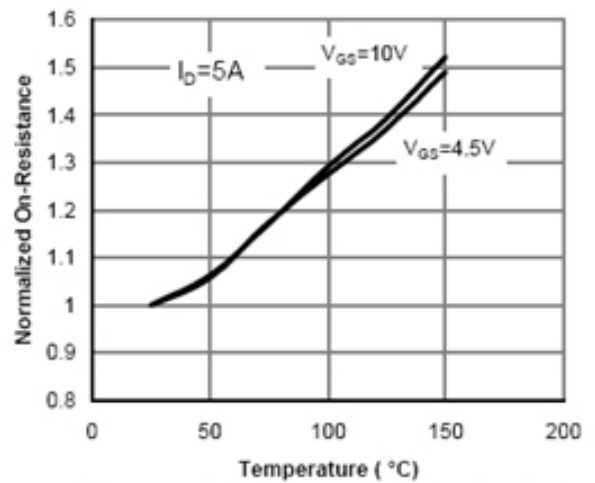

Figure 4: On-Resistance vs. Junction Temperature

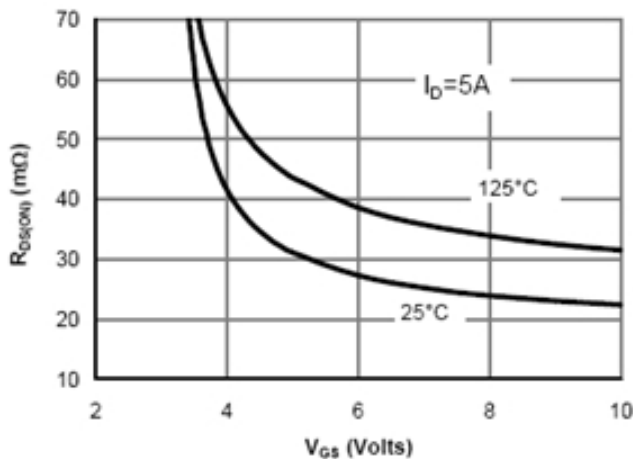

Figure 5: On-Resistance vs. Gate-Source Voltage

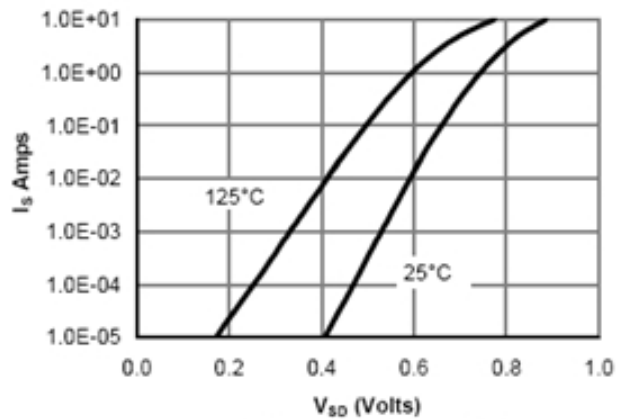

Figure 6: Body diode characteristics

N-CHANNEL TYPICAL ELECTRICAL AND THERMAL CHARACTERISTICS

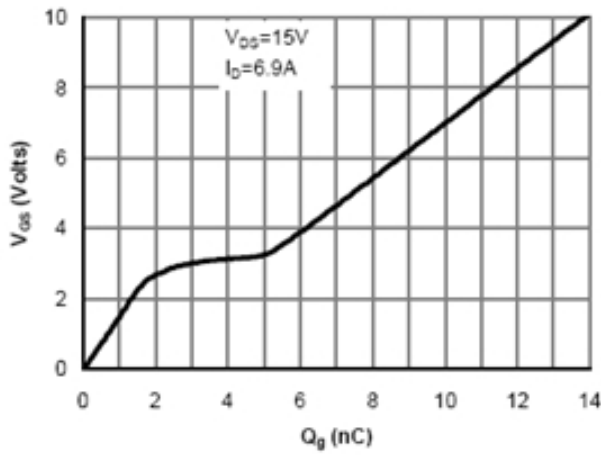

Figure 7: Gate-Charge characteristics

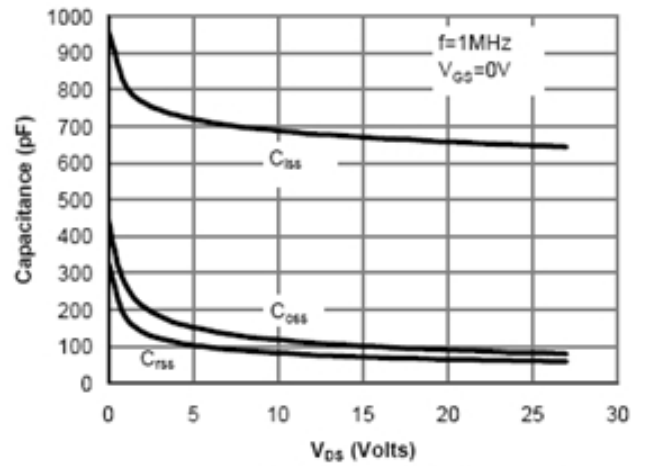

Figure 8: Capacitance Characteristics

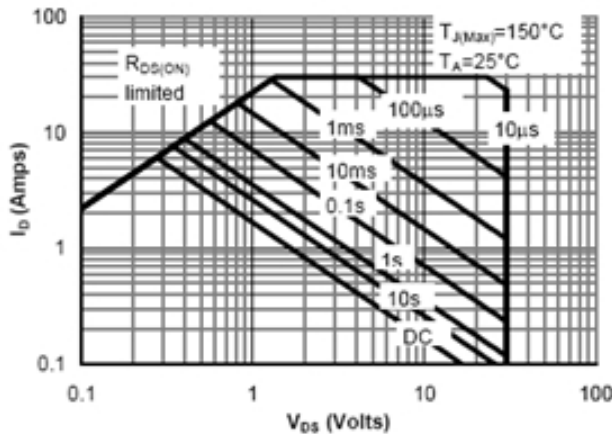

Figure 9: Maximum Forward Biased Safe Operating Area (Note E)

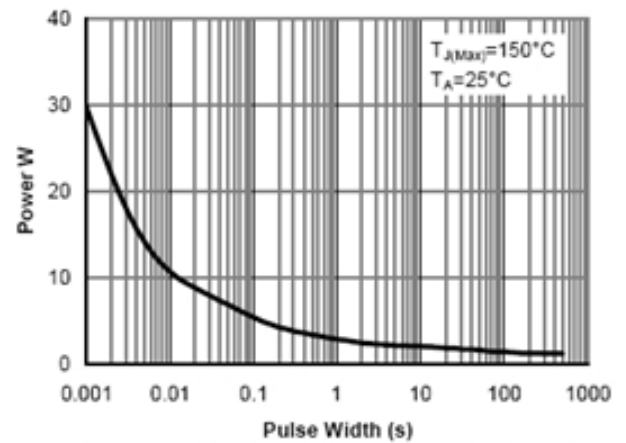

Figure 10: Single Pulse Power Rating Junction-to-Ambient (Note E)

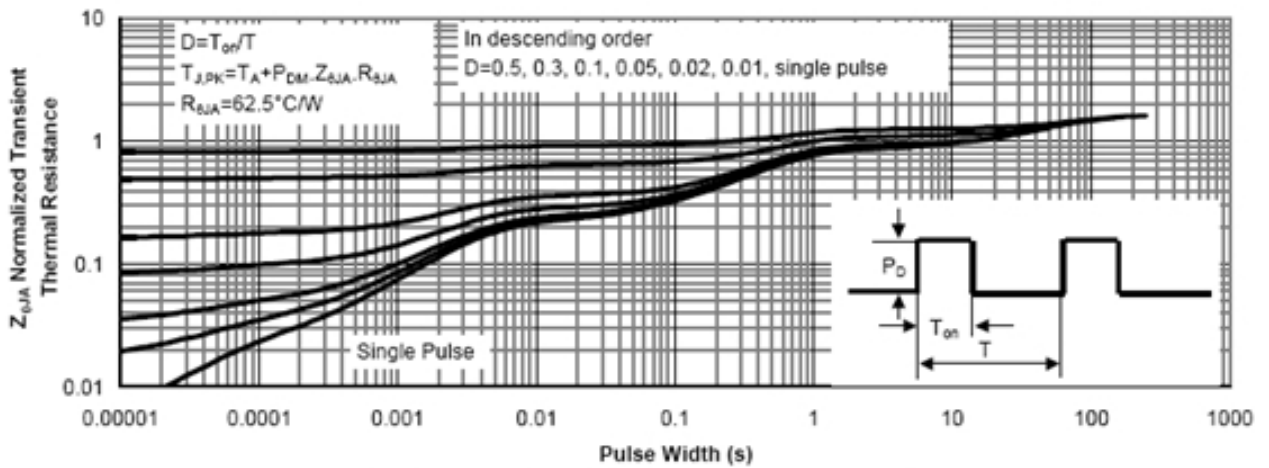

Figure 11: Normalized Maximum Transient Thermal Impedance

P-CHANNEL TYPICAL ELECTRICAL AND THERMAL CHARACTERISTICS

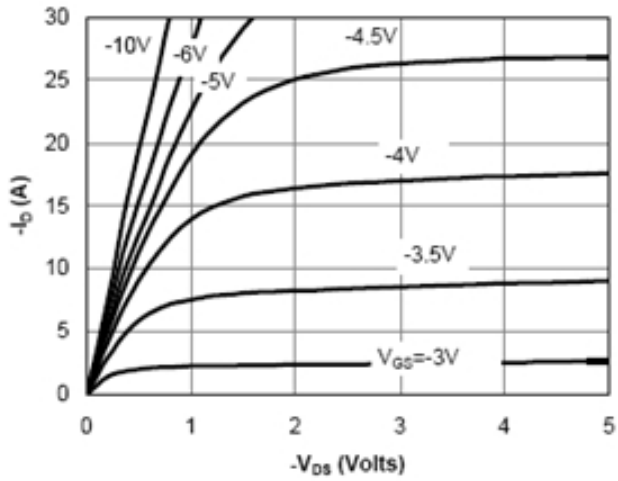

Fig 1: On-Region Characteristics

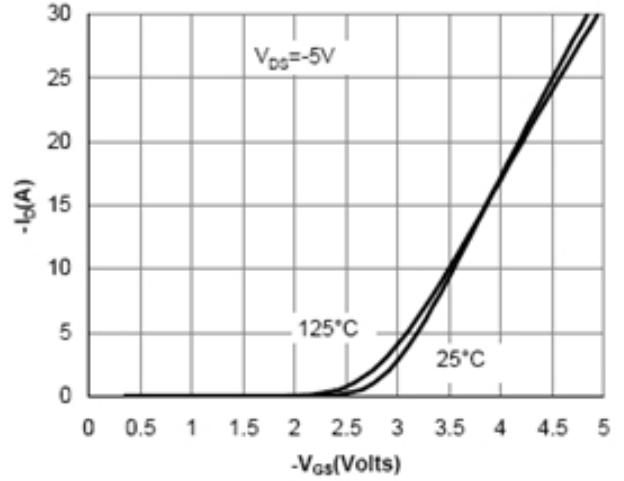

Figure 2: Transfer Characteristics

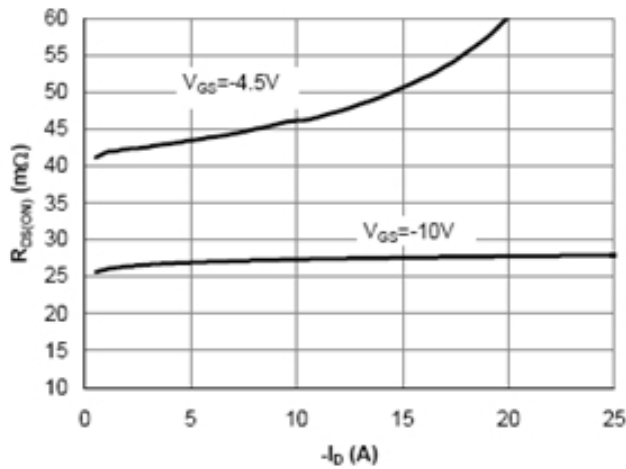

Figure 3: On-Resistance vs. Drain Current and Gate Voltage

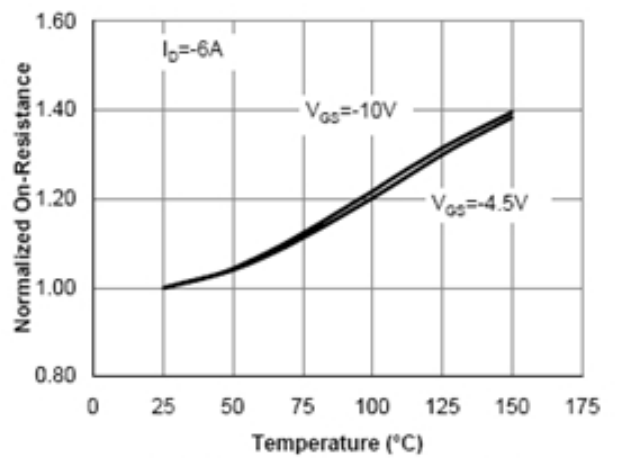

Figure 4: On-Resistance vs. Junction Temperature

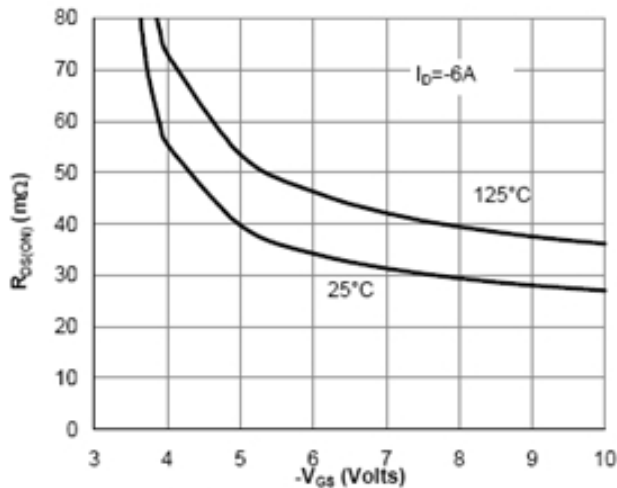

Figure 5: On-Resistance vs. Gate-Source Voltage

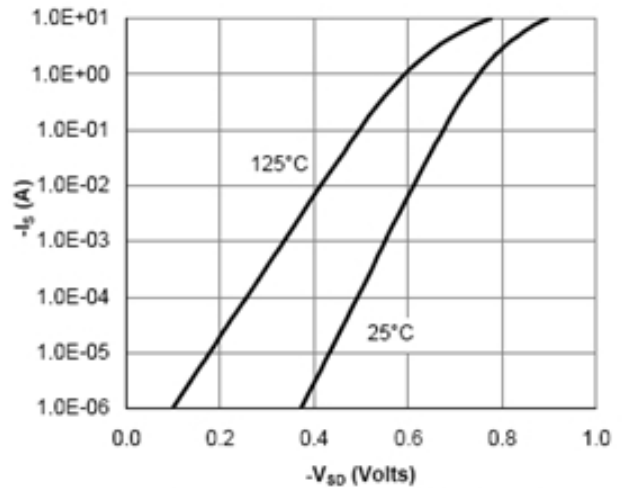

Figure 6: Body-Diode Characteristics

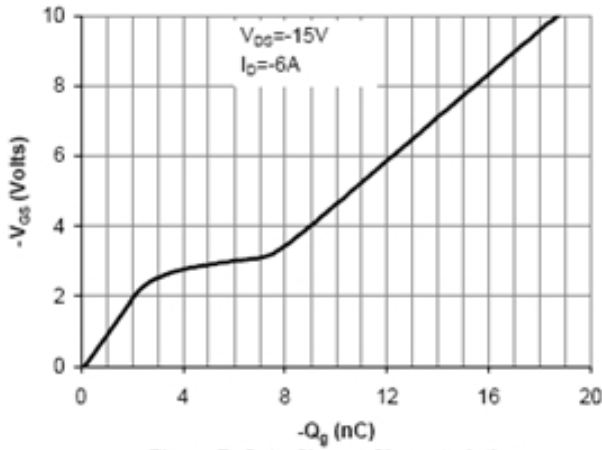

Figure 7: Gate-Charge Characteristics

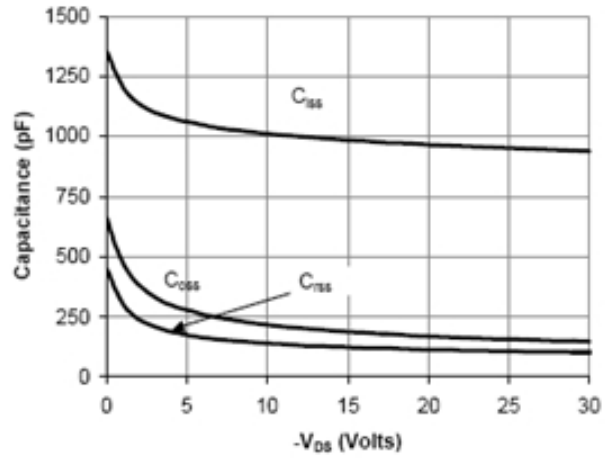

Figure 8: Capacitance Characteristics

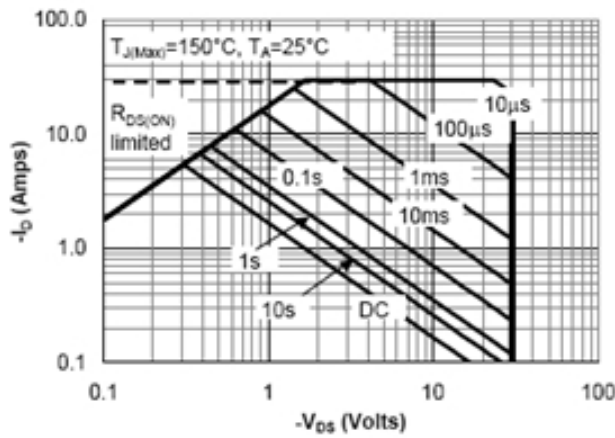

Figure 9: Maximum Forward Biased Safe Operating Area (Note E)

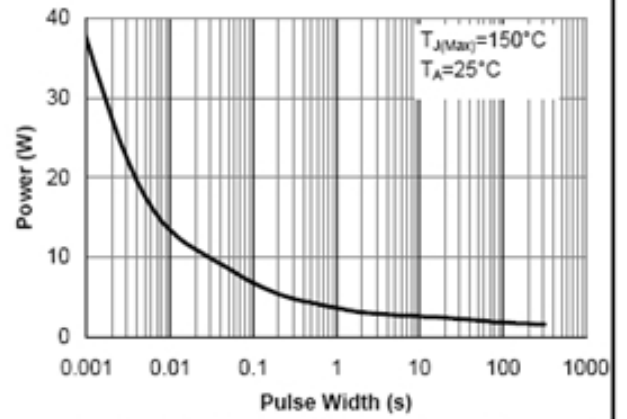

Figure 10: Single Pulse Power Rating Junction-to-Ambient (Note E)

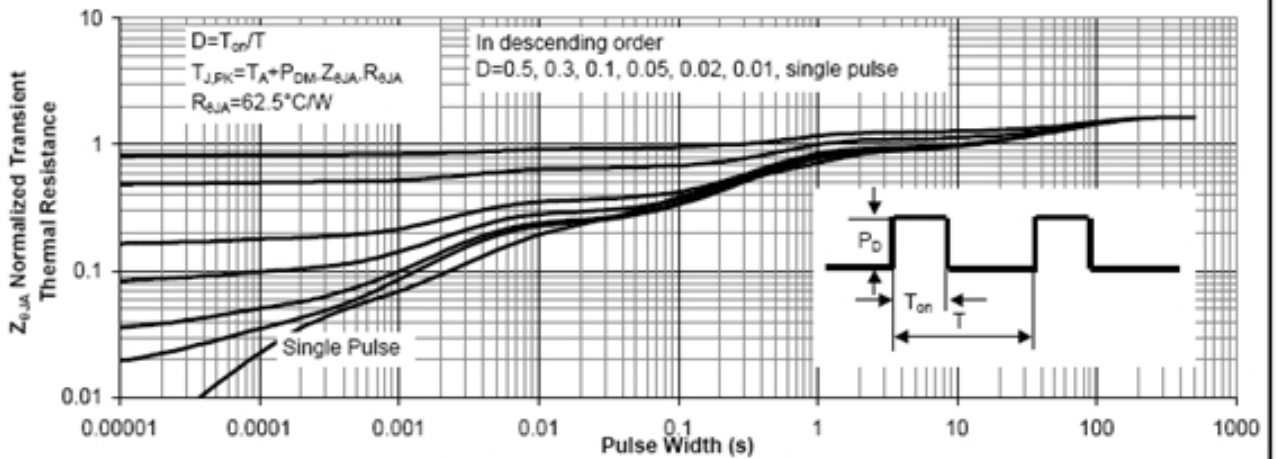
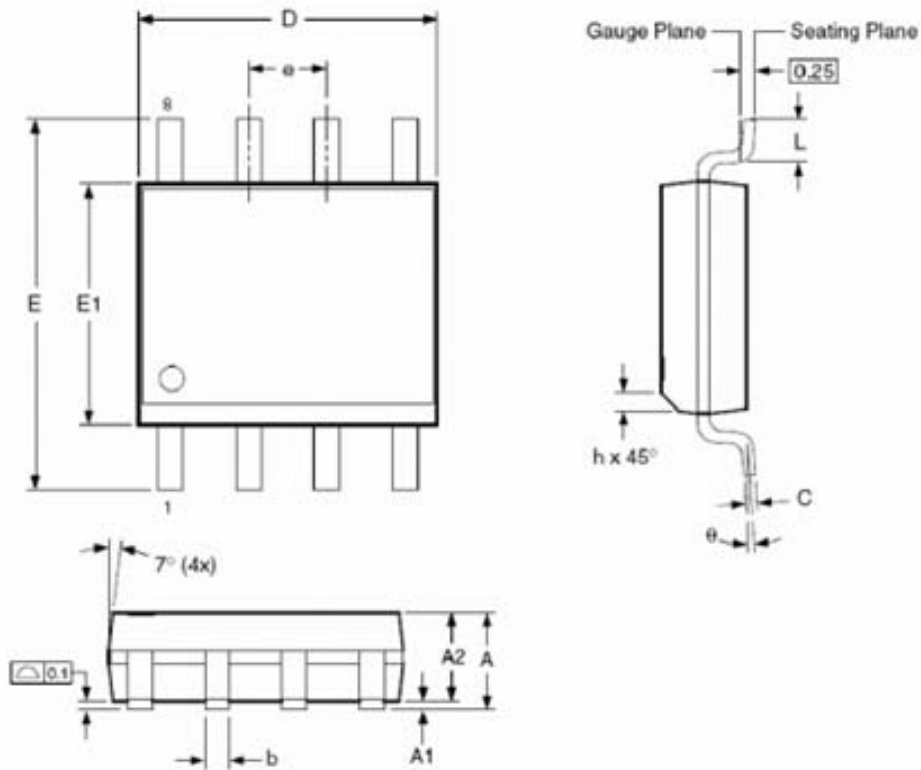

Figure 11: Normalized Maximum Transient Thermal Impedance

SOP-8 PACKAGE INFORMATION

Dimensions in Millimeters (UNIT:mm)



RECOMMENDED LAND PATTERN

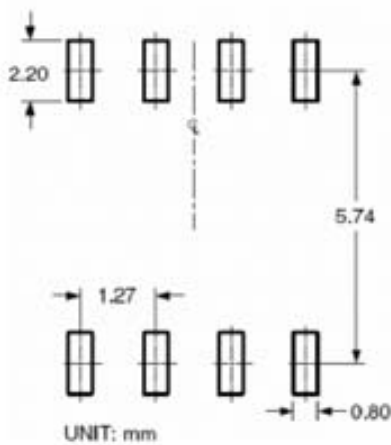

Dimensions in millimeters

Symbols	Min.	Nom.	Max.
A	1.35	1.65	1.75
A1	0.10	—	0.25
A2	1.25	1.50	1.65
b	0.31	—	0.51
c	0.17	—	0.25
D	4.80	4.90	5.00
E1	3.80	3.90	4.00
e	1.27 BSC		
E	5.80	6.00	6.20
h	0.25	—	0.50
L	0.40	—	1.27
θ	0°	—	8°

Dimensions in inches

Symbols	Min.	Nom.	Max.
A	0.053	0.065	0.069
A1	0.004	—	0.010
A2	0.049	0.059	0.065
b	0.012	—	0.020
c	0.007	—	0.010
D	0.189	0.193	0.197
E1	0.150	0.154	0.157
e	0.050 BSC		
E	0.228	0.236	0.244
h	0.010	—	0.020
L	0.016	—	0.050
θ	0°	—	8°

The SINO-IC logo is a registered trademark of ShangHai Sino-IC Microelectronics Co., Ltd.

© 2005 SINO-IC - Printed in China - All rights reserved.

SHANGHAI SINO-IC MICROELECTRONICS CO., LTD

Add: Building 3, Room 3401-03, No.200 Zhangheng Road, ZhangJiang Hi-Tech Park, Pudong, Shanghai 201203, China

Phone: +86-21-33932402 33932403 33932405 33933508 33933608 Fax:

+86-21-33932401

Email: webmaster@sino-ic.com

Website: <http://www.sino-ic.com>