

SE4060,SE6080S,SE8090S

N-Channel Enhancement-Mode MOSFET

Revision: A

General Description

Thigh Density Cell Design For Ultra Low On-Resistance Fully Characterized Avalanche Voltage and Current Improved Shoot-Through FOM

- Simple Drive Requirement
- Small Package Outline
- Surface Mount Device

Features

For a single MOSFET

- $V_{DS} = 40V$
- $R_{DS(ON)} = 7m\Omega @ V_{GS}=10V$

Pin configurations

See Diagram below

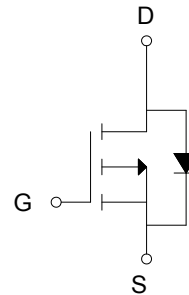
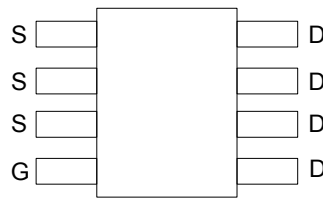

Absolute Maximum Ratings

Parameter	Symbol	Rating			Units
		4060	6080S	8090S	
Drain-Source Voltage	V_{DS}	40	60	80	V
Gate-Source Voltage	V_{GS}	± 20	± 20	± 20	V
Drain Current	Continuous	60	80	80	A
	Pulsed	200	220	320	
Total Power Dissipation	@TA=25°C	65	110	125	W
Operating Junction Temperature Range	T_J	-55 to 175			°C

SE4060,SE6080S,SE8090S

Electrical Characteristics (T_J=25°C unless otherwise noted)						
Symbol	Parameter	Test Conditions	Min	Typ	Max	Units
OFF CHARACTERISTICS						
SE4060						
B _V DSS	Drain-Source Breakdown Voltage	I _D =250μA, V _{GS} =0 V	40	45		V
I _{DSS}	Drain to Source Leakage Current	V _{DS} = 40V, V _{GS} =0V			1	μA
I _{GSS}	Gate-Body Leakage Current	V _{GS} =20 V			100	nA
V _{GS(th)}	Gate Threshold Voltage	V _{DS} = V _{GS} , I _D =250μA	1.2	1.6	2.5	V
R _{DS(ON)}	Static Drain-Source On-Resistance	V _{GS} =10V, I _D =20A	-	7	13	mΩ
SE6080S						
B _V DSS	Drain-Source Breakdown Voltage	I _D =250μA, V _{GS} =0 V	60			V
I _{DSS}	Drain to Source Leakage Current	V _{DS} = 48V, V _{GS} =0V			1	μA
I _{GSS}	Gate-Body Leakage Current	V _{GS} =20V			100	nA
V _{GS(th)}	Gate Threshold Voltage	V _{DS} = V _{GS} , I _D =250μA	2		4	V
R _{DS(ON)}	Static Drain-Source On-Resistance	V _{GS} =10V, I _D =40A		7	8.5	mΩ
SE8090S						
B _V DSS	Drain-Source Breakdown Voltage	I _D =250μA, V _{GS} =0 V	80			V
I _{DSS}	Drain to Source Leakage Current	V _{DS} = 80V, V _{GS} =0V			1	μA
I _{GSS}	Gate-Body Leakage Current	V _{GS} =20V			100	nA
V _{GS(th)}	Gate Threshold Voltage	V _{DS} = V _{GS} , I _D =250μA	2	3	4	V
R _{DS(ON)}	Static Drain-Source On-Resistance ²	V _{GS} =10V, I _D =40A	-	9	11	mΩ
DYNAMIC PARAMETERS						
SE4060						
C _{iss}	Input Capacitance	V _{GS} =0V, V _{DS} =20V, f=1MHz		1800		pF
C _{oss}	Output Capacitance			280		pF
C _{rss}	Reverse Transfer Capacitance			190		pF
SE6080S						
C _{iss}	Input Capacitance	V _{GS} =0V, V _{DS} =40V, f=1MHz		7765		pF
C _{oss}	Output Capacitance			960		pF
C _{rss}	Reverse Transfer Capacitance			66		pF
SE8090S						
C _{iss}	Input Capacitance	V _{GS} =0V, V _{DS} =40V, f=1MHz		4120		pF
C _{oss}	Output Capacitance			520		pF
C _{rss}	Reverse Transfer Capacitance			200		pF

Electrical Characteristics (T _J =25°C unless otherwise noted)						
Symbol	Parameter	Test Conditions	Min	Typ	Max	Units
SWITCHING PARAMETERS						
SE4060						
t _{d(on)}	Turn-On Delay Time	V _{DD} =20V, R _L =1Ω R _G =3Ω		6.4		ns
t _{d(off)}	Turn-Off Delay Time			29.6		ns
t _{d(r)}	Turn-On Rise Time			17.2		ns
t _{d(f)}	Turn-Off Fall Time			16.8		ns
SE6080S						
t _{d(on)}	Turn-On Delay Time	V _{GS} =10V, V _{DS} =40V, R _{GEN} =3Ω		24		ns
t _{d(off)}	Turn-Off Delay Time			55		ns
t _{d(r)}	Turn-On Rise Time			18		ns
t _{d(f)}	Turn-Off Fall Time			17		ns
SE8090S						
t _{d(on)}	Turn-On Delay Time	V _{GS} =10V, V _{DS} =40V, R _{GEN} =4.7Ω I _D =2A		34		ns
t _{d(off)}	Turn-Off Delay Time			103		ns
t _{d(r)}	Turn-On Rise Time			95		ns
t _{d(f)}	Turn-Off Fall Time			33		ns
Thermal Resistance						
Symbol	Parameter		Typ	Max		Units
R _{θJA}	Junction to Ambient (each bin with recommended lands)		-	2.3		°C/W

SE4060,SE6080S,SE8090S

Test Circuit

1) E_{AS} Test Circuit

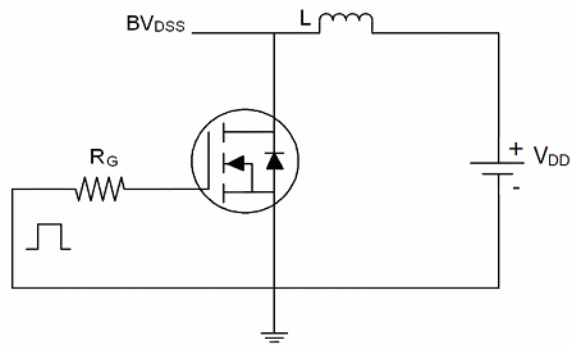

2) Gate Charge Test Circuit

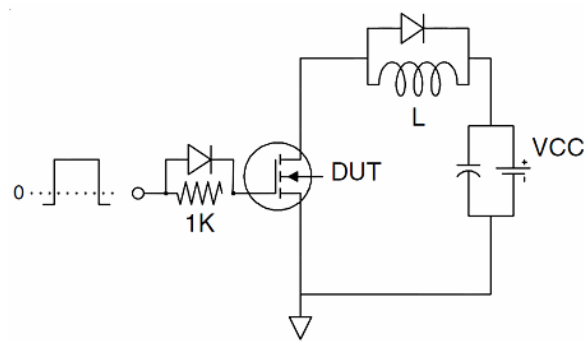

3) Switch Time Test Circuit

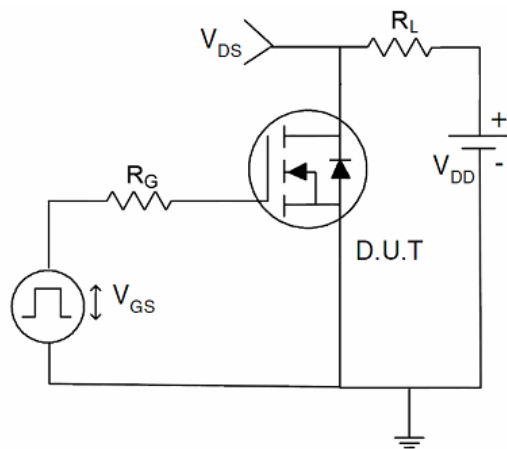

Typical Characteristics-SE4060

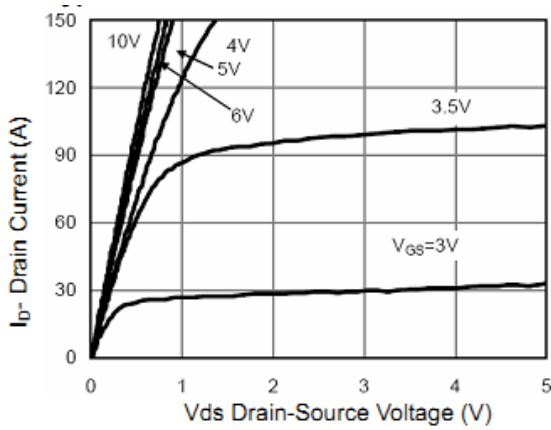

Figure 1 Output Characteristics

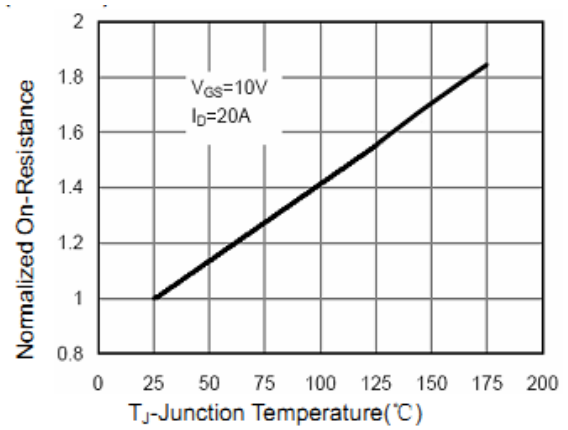

Figure 4 Rdson-Junction Temperature

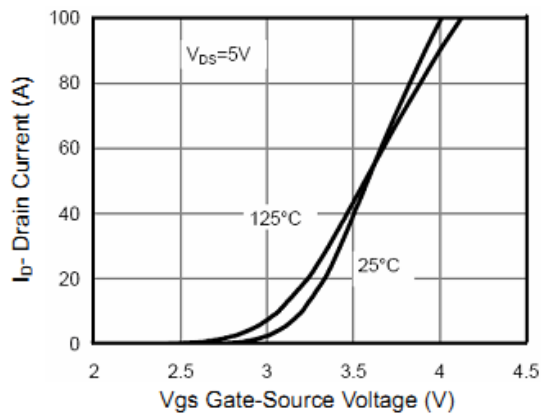

Figure 2 Transfer Characteristics

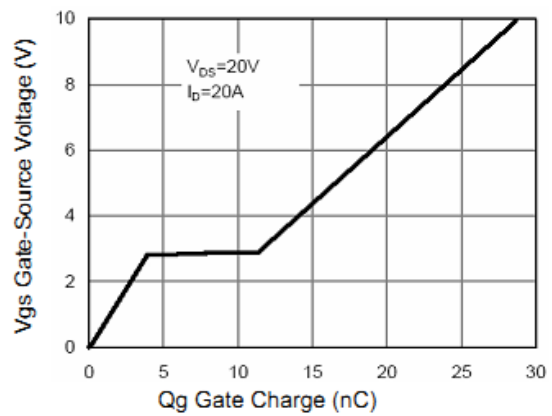

Figure 5 Gate Charge

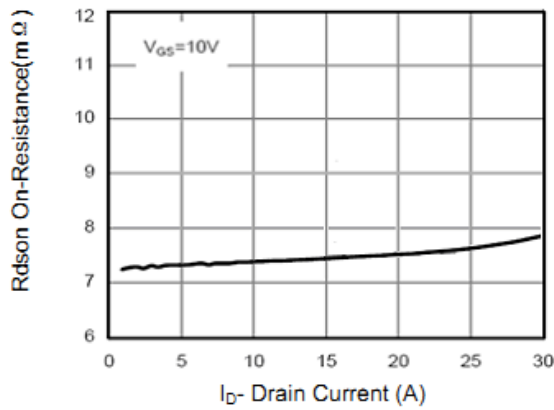

Figure 3 Rdson- Drain Current

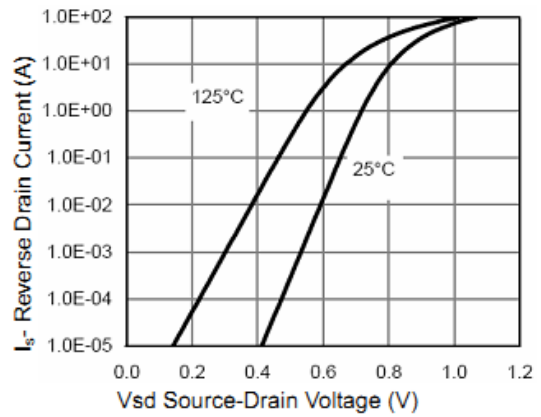

Figure 6 Source- Drain Diode Forward

Typical Characteristics-SE4060

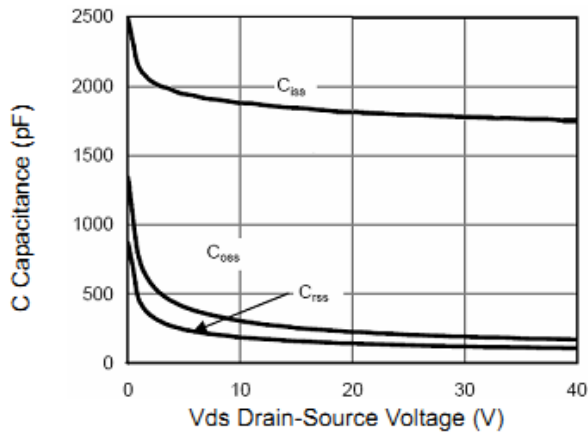

Figure 7 Capacitance vs Vds

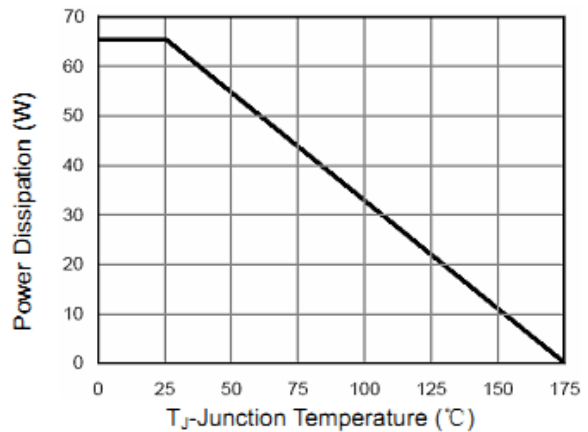

Figure 9 Power De-rating

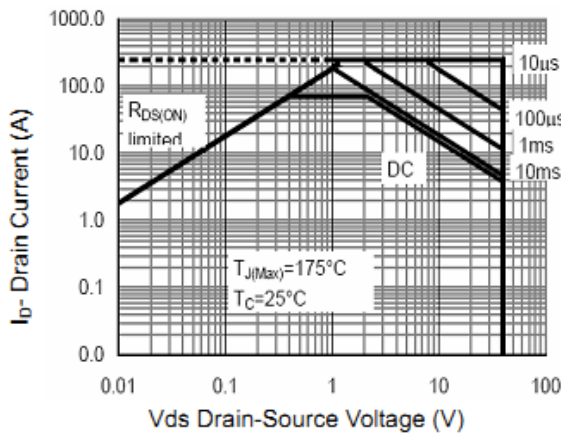

Figure 8 Safe Operation Area

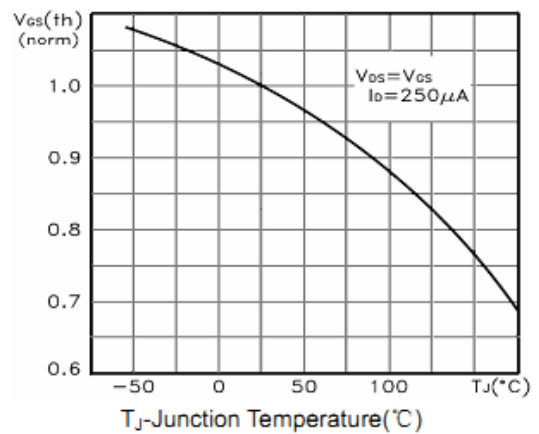

Figure 10 $V_{GS(th)}$ vs Junction Temperature

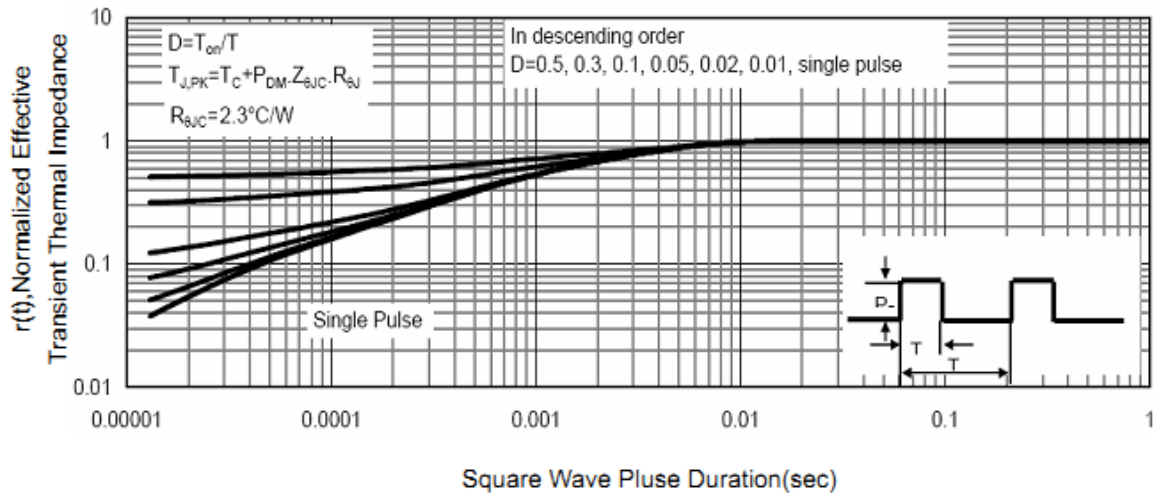

Figure 11 Normalized Maximum Transient Thermal Impedance

Typical Characteristics-SE6080S

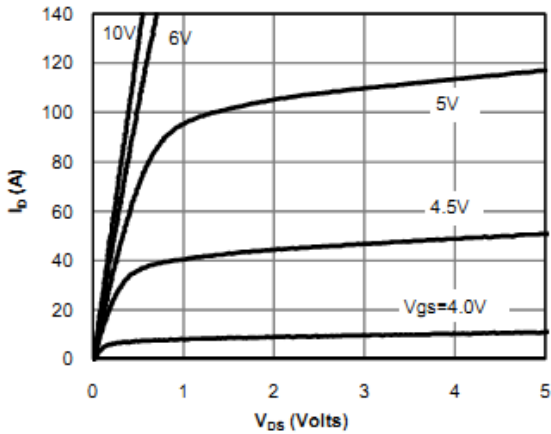

Fig 1: On-Region Characteristics (Note E)

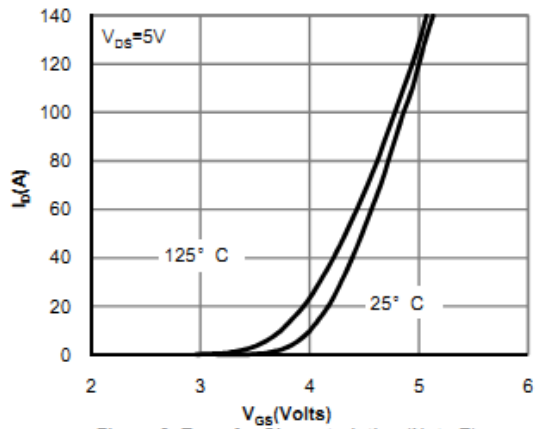

Figure 2: Transfer Characteristics (Note E)

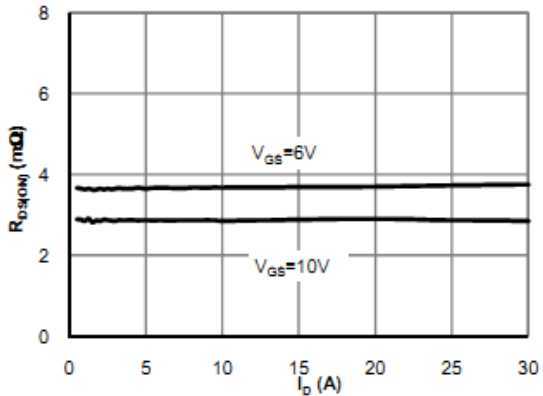

Figure 3: On-Resistance vs. Drain Current and Gate Voltage (Note E)

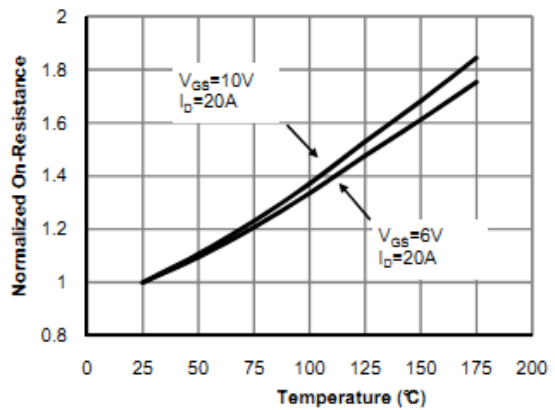

Figure 4: On-Resistance vs. Junction Temperature (Note E)

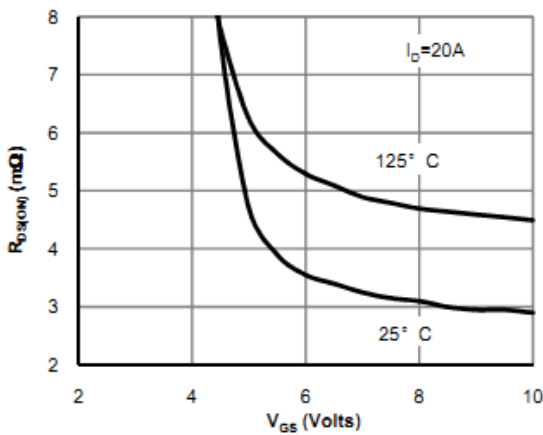

Figure 5: On-Resistance vs. Gate-Source Voltage (Note E)

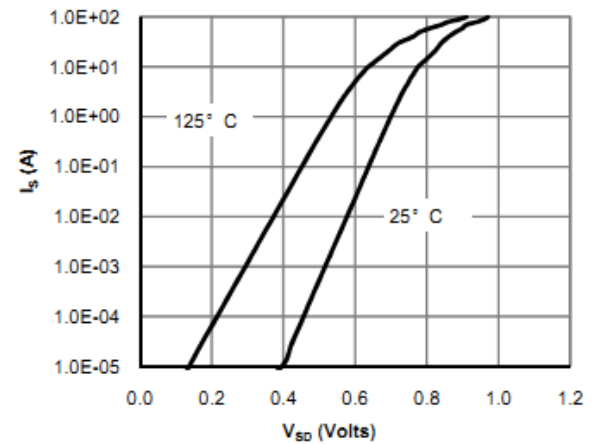

Figure 6: Body-Diode Characteristics (Note E)

Typical Characteristics-SE6080S

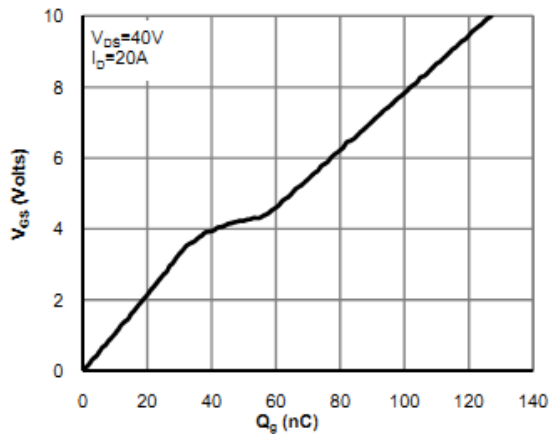

Figure 7: Gate-Charge Characteristics

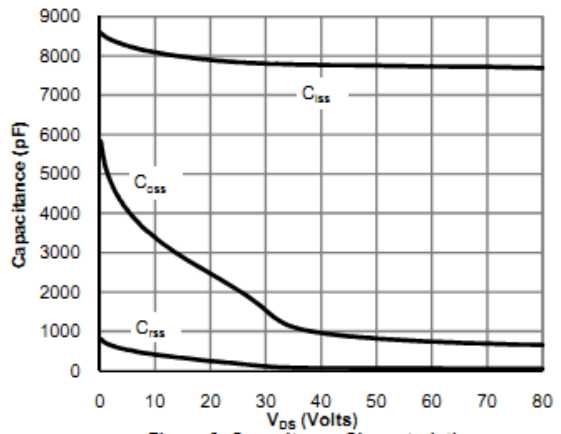

Figure 8: Capacitance Characteristics

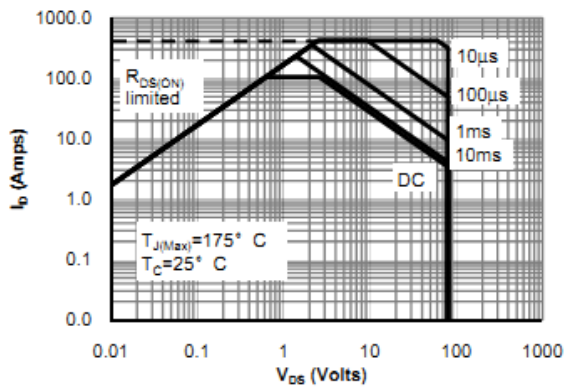

Figure 9: Maximum Forward Biased Safe Operating Area (Note F)

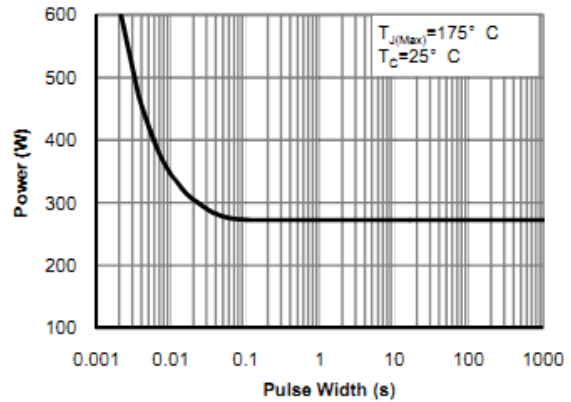

Figure 10: Single Pulse Power Rating Junction-to-Case (Note F)

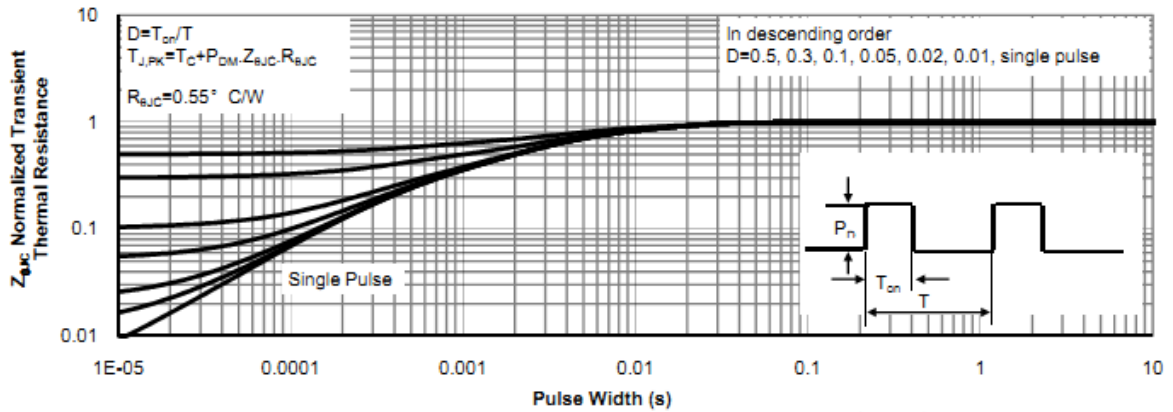
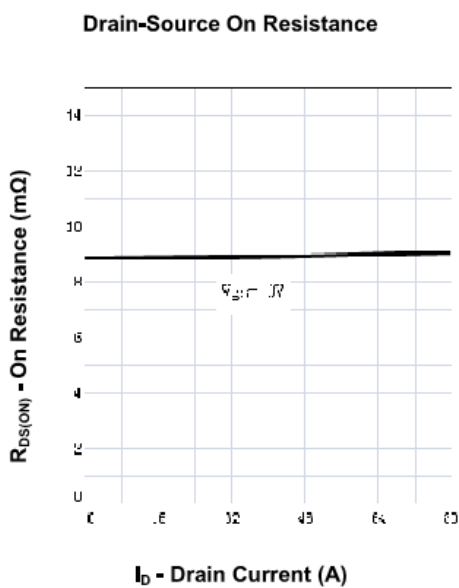
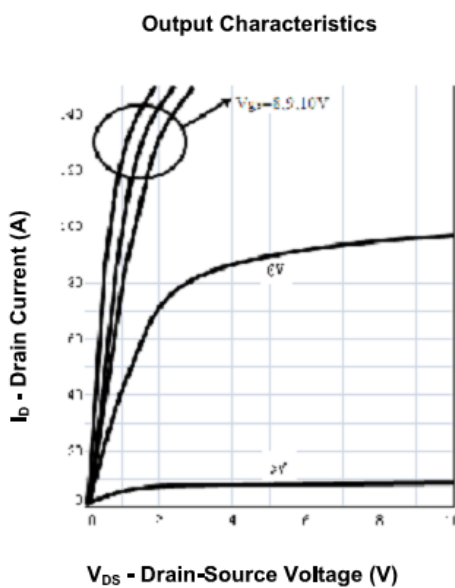
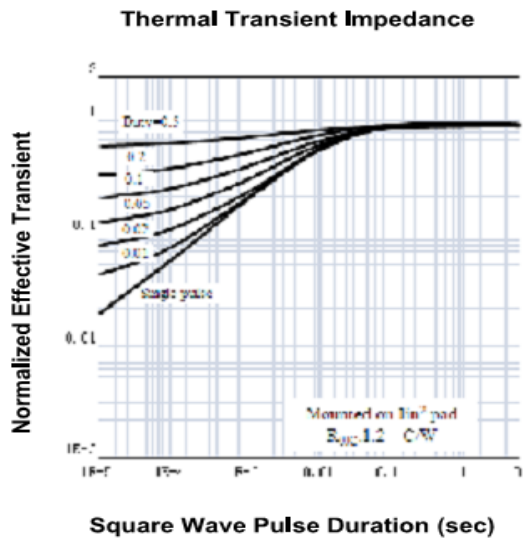
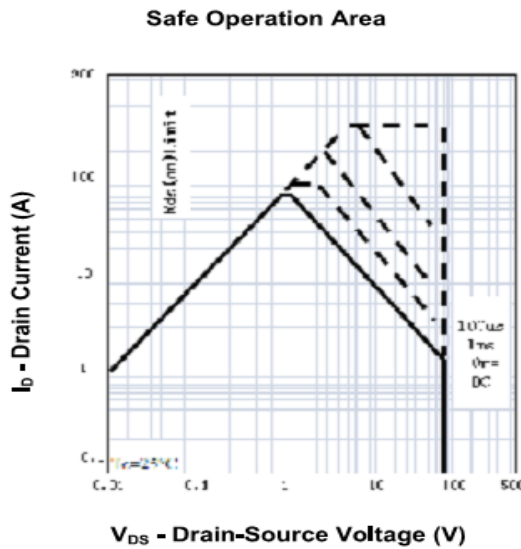
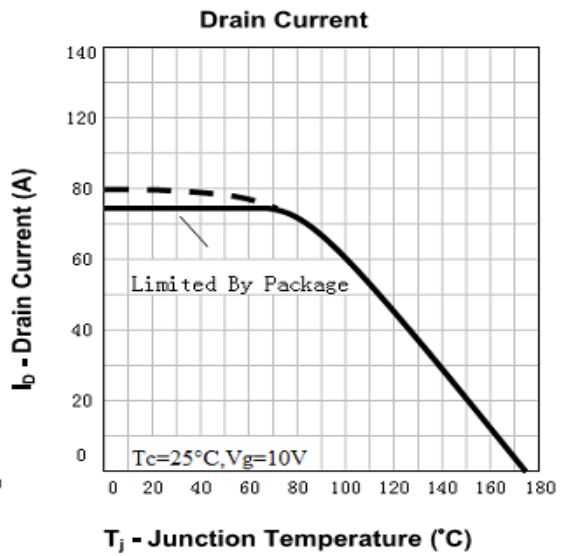
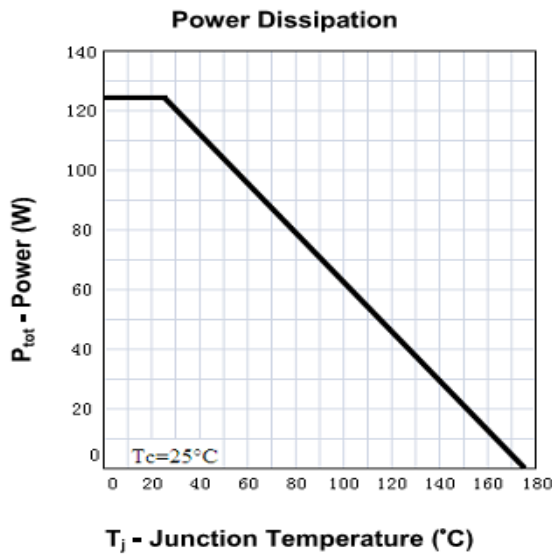
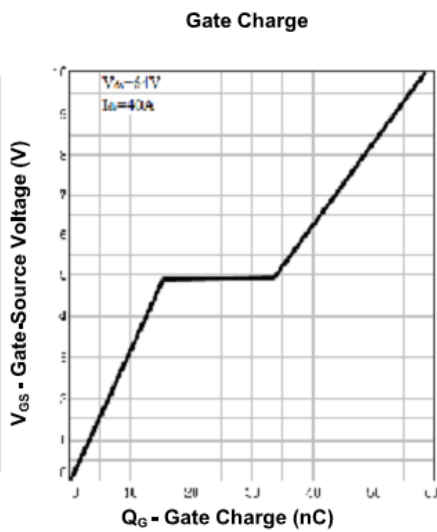
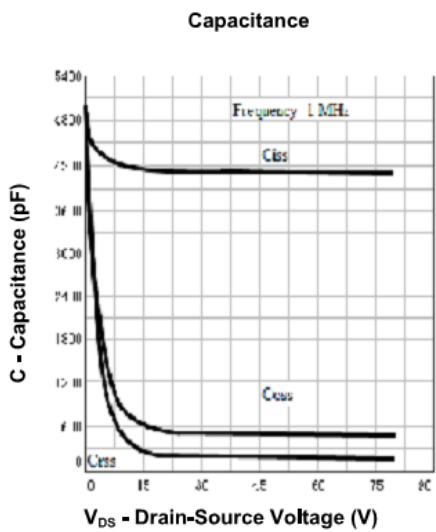
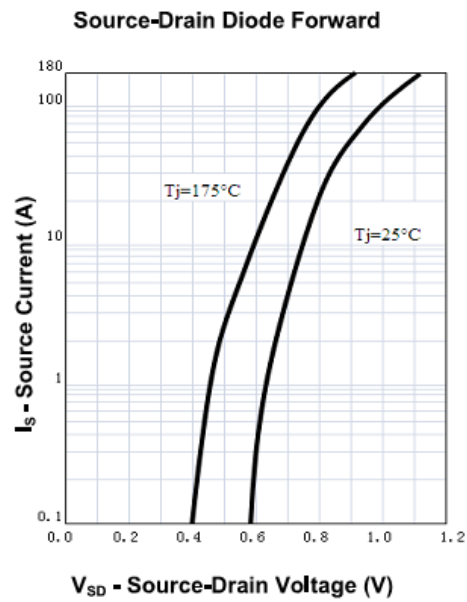
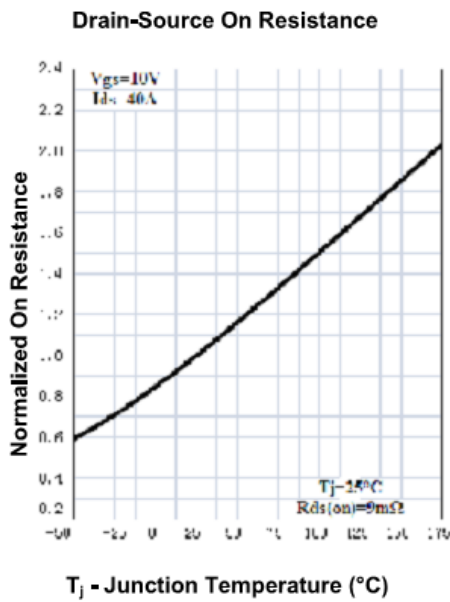
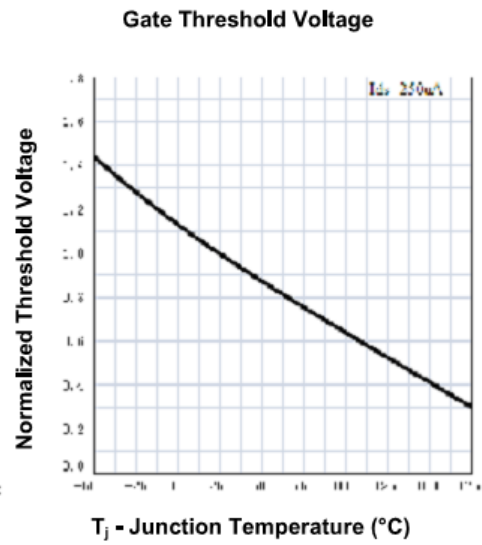
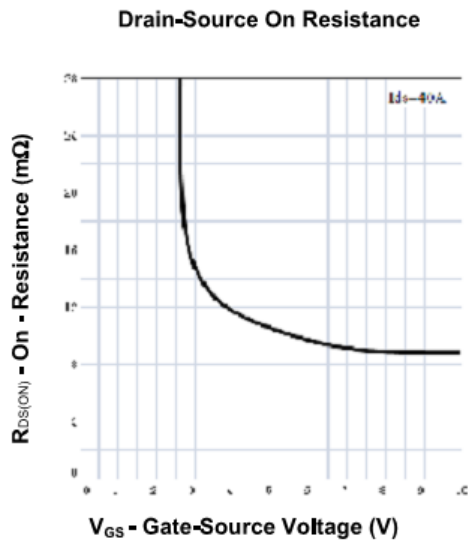

Figure 11: Normalized Maximum Transient Thermal Impedance (Note F)

Typical Characteristics-SE8090S



Typical Characteristics-SE8090S



SE4060,SE6080S,SE8090S

Package Outline Dimension

SOP-8

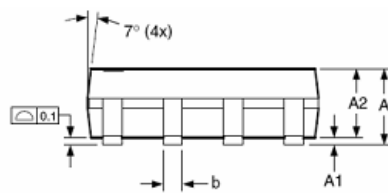
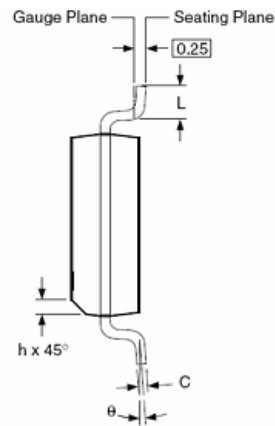
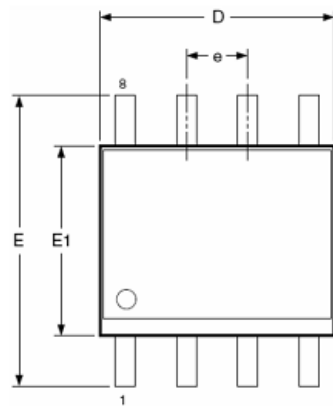

RECOMMENDED LAND PATTERN

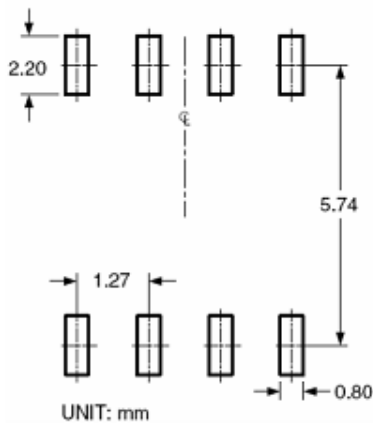

Dimensions in millimeters

Symbols	Min.	Nom.	Max.
A	1.35	1.65	1.75
A1	0.10	—	0.25
A2	1.25	1.50	1.65
b	0.31	—	0.51
c	0.17	—	0.25
D	4.80	4.90	5.00
E1	3.80	3.90	4.00
e	1.27 BSC		
E	5.80	6.00	6.20
h	0.25	—	0.50
L	0.40	—	1.27
θ	0°	—	8°

Dimensions in inches

Symbols	Min.	Nom.	Max.
A	0.053	0.065	0.069
A1	0.004	—	0.010
A2	0.049	0.059	0.065
b	0.012	—	0.020
c	0.007	—	0.010
D	0.189	0.193	0.197
E1	0.150	0.154	0.157
e	0.050 BSC		
E	0.228	0.236	0.244
h	0.010	—	0.020
L	0.016	—	0.050
θ	0°	—	8°

NOTES:

1. Dimensions are inclusive of plating
2. Package body sizes exclude mold flash and gate burrs. Mold flash at the non-lead sides should be less than 6 mils.
3. Dimension L is measured in gauge plane.
4. Controlling dimension is millimeter, converted inch dimensions are not necessarily exact.

SE4060B,SE6080S,SE8090S

The SINO-IC logo is a registered trademark of ShangHai Sino-IC Microelectronics Co., Ltd.

© 2005 SINO-IC - Printed in China - All rights reserved.

SHANGHAI SINO-IC MICROELECTRONICS CO., LTD

Add: Building 3, Room 3401-03, No.200 Zhangheng Road,
ZhangJiang Hi-Tech Park, Pudong, Shanghai 201203, China

Phone: +86-21-33932402 33932403

33932405 33933508 33933608

Fax: +86-21-33932401

Email: webmaster@sino-ic.com

Website: <http://www.sino-ic.com>