

SE3407A

P-Channel Enhancement-Mode MOSFET

Revision: A

General Description

Advanced trench technology to provide excellent $R_{DS(ON)}$, low gate charge and low operation voltage. This device is suitable for using as a load switch or in PWM applications.

- Simple Drive Requirement
- Small Package Outline
- Surface Mount Device

Features

For a single MOSFET

- $V_{DS} = -30V$
- $R_{DS(ON)} = 40m\Omega @ V_{GS}=-10V$

Pin configurations

See Diagram below

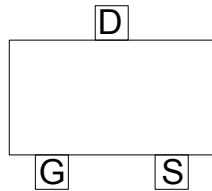

SOT-23 and SOT23-3

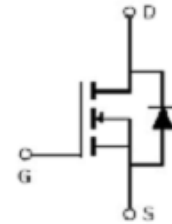

Absolute Maximum Ratings

Parameter		Symbol	Rating	Units
Drain-Source Voltage		V_{DS}	-30	V
Gate-Source Voltage		V_{GS}	± 20	V
Drain Current	Continuous	I_D	-4.3	A
	Pulsed		-20	
Total Power Dissipation	@ $T_A=25^\circ C$	P_D	1.5	W
Operating Junction Temperature Range		T_J	-55 to 150	$^\circ C$

SE3407A

Electrical Characteristics (T _J =25°C unless otherwise noted)						
Symbol	Parameter	Test Conditions	Min	Typ	Max	Units
OFF CHARACTERISTICS (Note 2)						
BV _{DSS}	Drain-Source Breakdown Voltage	I _D =-250μA, V _{GS} =0 V	-30			V
I _{DSS}	Drain to Source Leakage Current	V _{DS} = -24V, V _{GS} =0V			-1	μA
I _{GSS}	Gate-Body Leakage Current	V _{GS} = 20V			100	nA
V _{GS(th)}	Gate Threshold Voltage	V _{DS} = V _{GS} , I _D =-250μA	-0.7		-1.3	V
R _{DS(ON)}	Static Drain-Source On-Resistance	V _{GS} =-10V, I _D =-4.2A	-	40	52	mΩ
		V _{GS} =-4.5V, I _D =-4A		64	87	mΩ
DYNAMIC PARAMETERS						
C _{iss}	Input Capacitance	V _{GS} =0V, V _{DS} =-15V, f=1MHz		700		pF
C _{oss}	Output Capacitance			120		pF
C _{rss}	Reverse Transfer Capacitance			75		pF
SWITCHING PARAMETERS						
Q _g	Total Gate Charge ²	V _{GS} =-10V, V _{DS} =-15V, I _D =-4A		14		nC
Q _{gs}	Gate Source Charge			3.1		nC
Q _{gd}	Gate Drain Charge			3		nC
t _{d(on)}	Turn-On Delay Time	V _{GS} =-10V, V _{DS} =-15V, R _{GEN} =3Ω, R _L =3.6Ω		9		ns
t _{d(off)}	Turn-Off Delay Time			28		ns
t _{d(r)}	Turn-On Rise Time			5		ns
t _{d(f)}	Turn-Off Fall Time			13.5		ns
Thermal Resistance						
Symbol	Parameter		Typ	Max	Units	
R _{θJA}	Thermal Resistance, Junction to Ambient		-	90	°C/W	

Test Circuits and Waveform

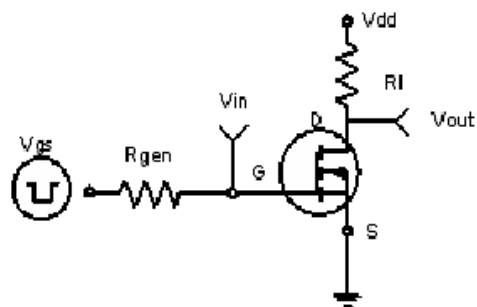

Figure 1: Switching Test Circuit

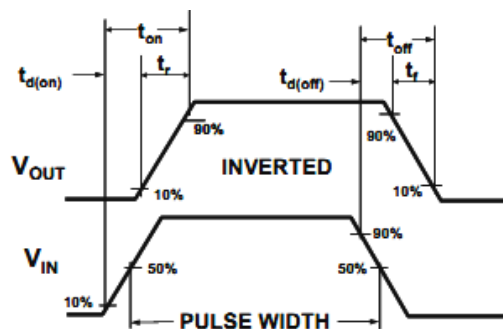

Figure 2: Switching Waveforms

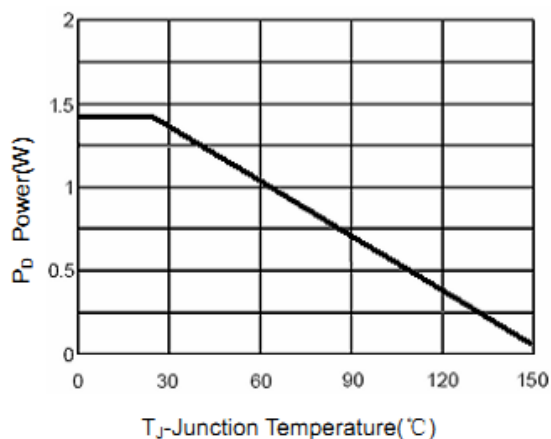

Figure 3 Power Dissipation

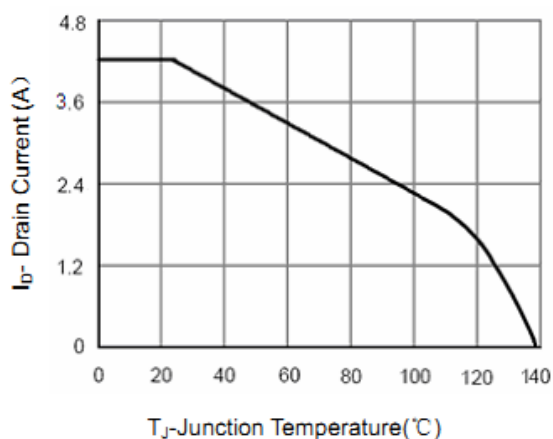

Figure 4 Drain Current

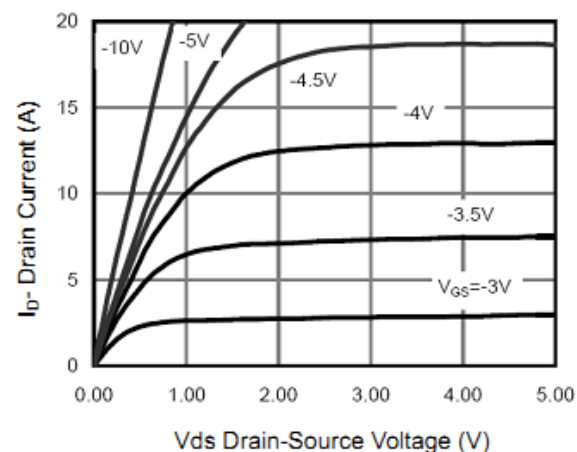

Figure 5 Output Characteristics

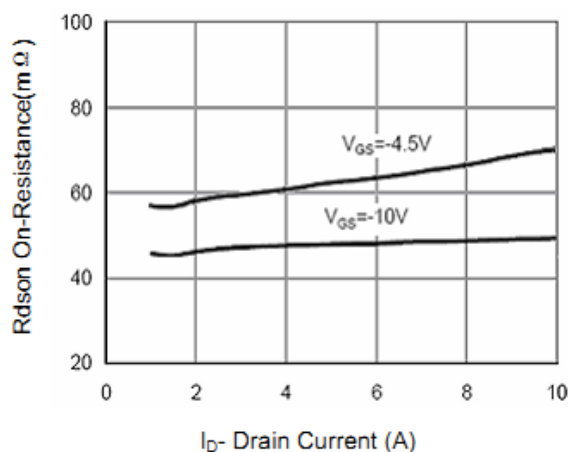

Figure 6 Drain-Source On-Resistance

Typical Characteristics

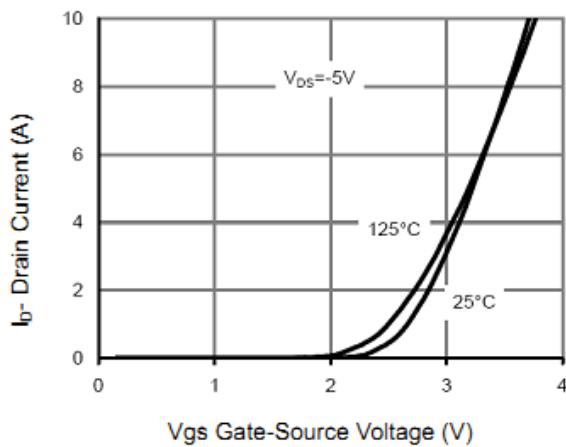

Figure 7 Transfer Characteristics

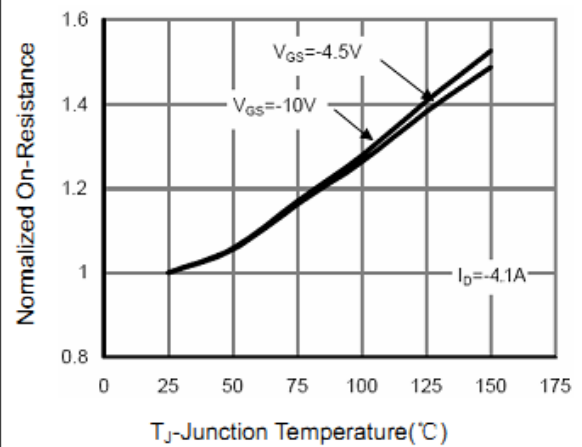

Figure 8 Drain-Source On-Resistance

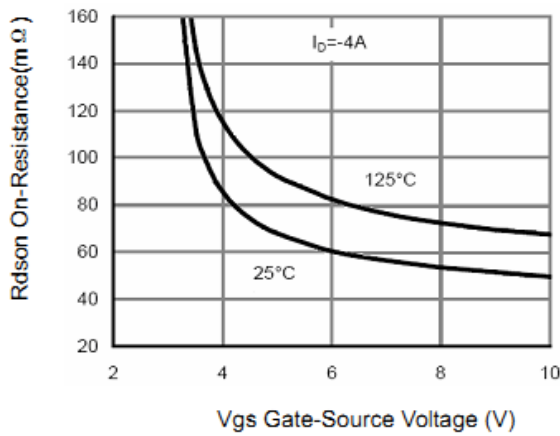

Figure 9 Rdson vs V_GS

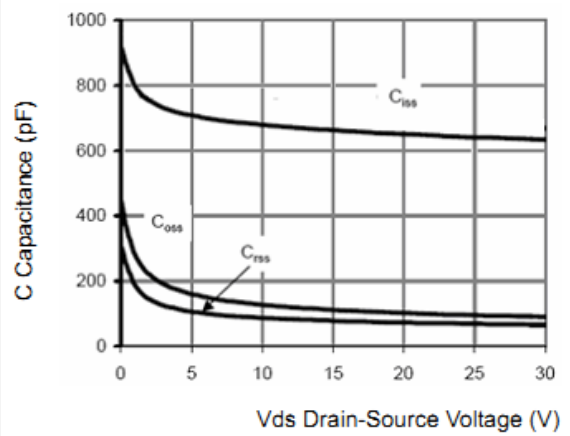

Figure 10 Capacitance vs V_DS

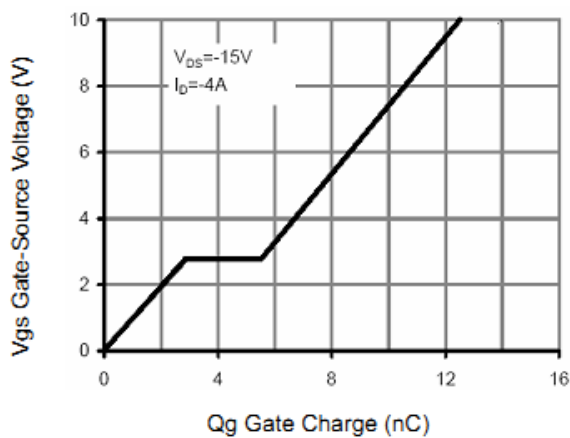

Figure 11 Gate Charge

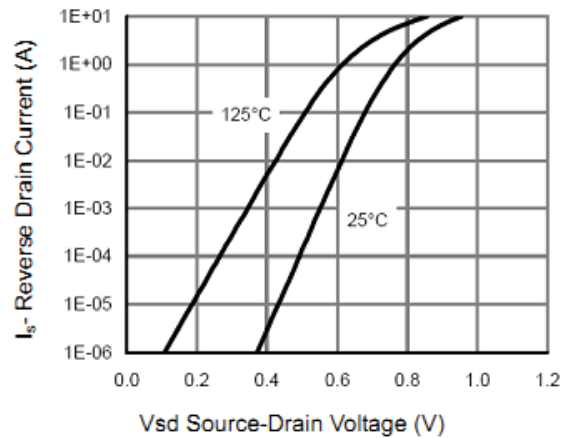

Figure 12 Source-Drain Diode Forward

Typical Characteristics

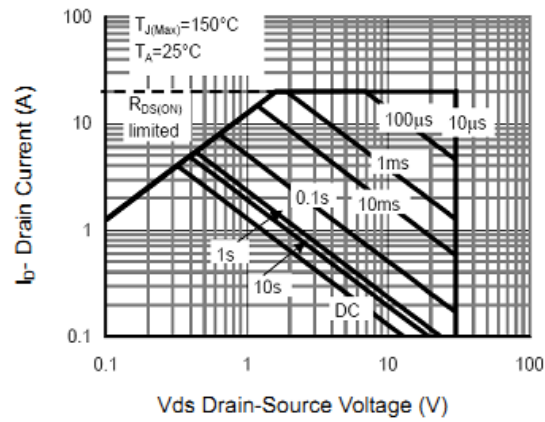

Figure 13 Safe Operation Area

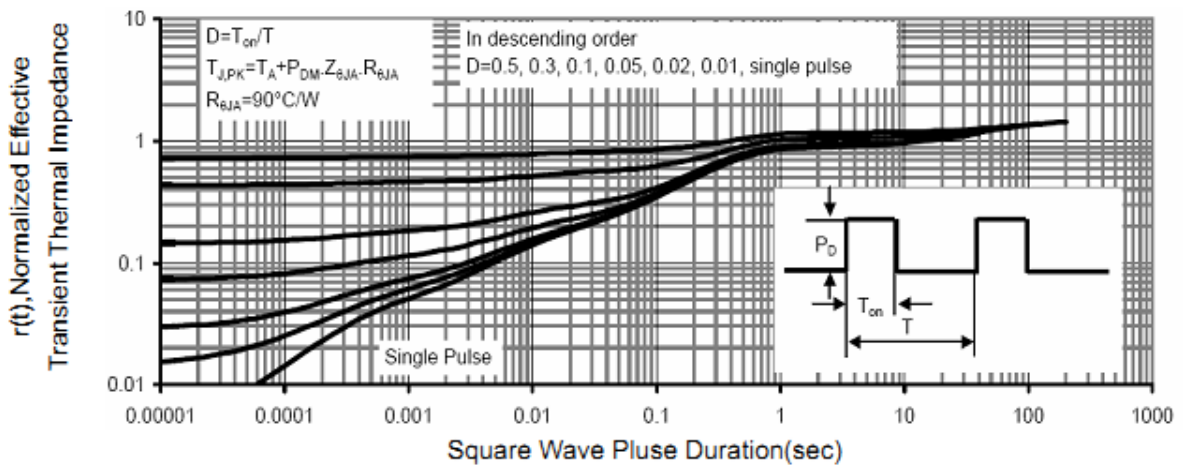
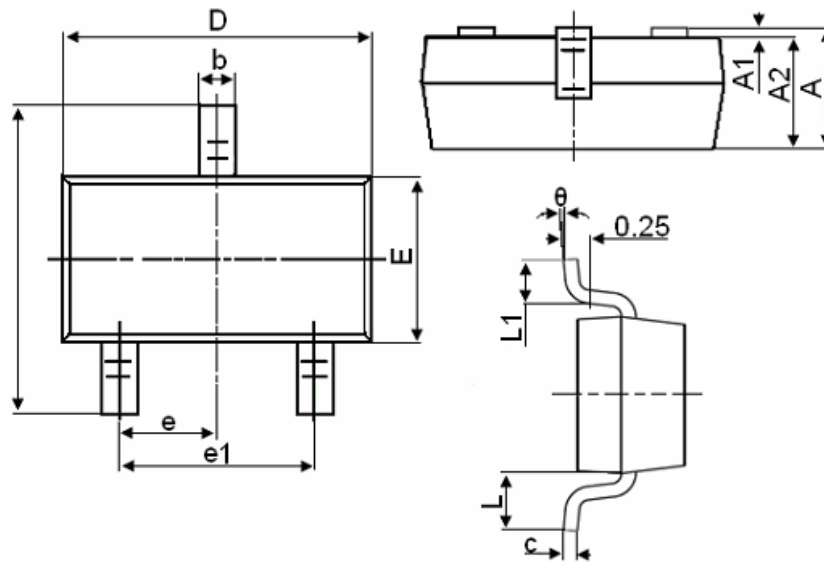

Figure 14 Normalized Maximum Transient Thermal Impedance

SE3407A

Package Outline Dimension

SOT-23



Symbol	Dimensions in Millimeters	
	MIN.	MAX.
A	0.900	1.150
A1	0.000	0.100
A2	0.900	1.050
b	0.300	0.500
c	0.080	0.150
D	2.800	3.000
E	1.200	1.400
E1	2.250	2.550
e	0.950TYP	
e1	1.800	2.000
L	0.550REF	
L1	0.300	0.500
theta	0°	8°

SOT-23-3

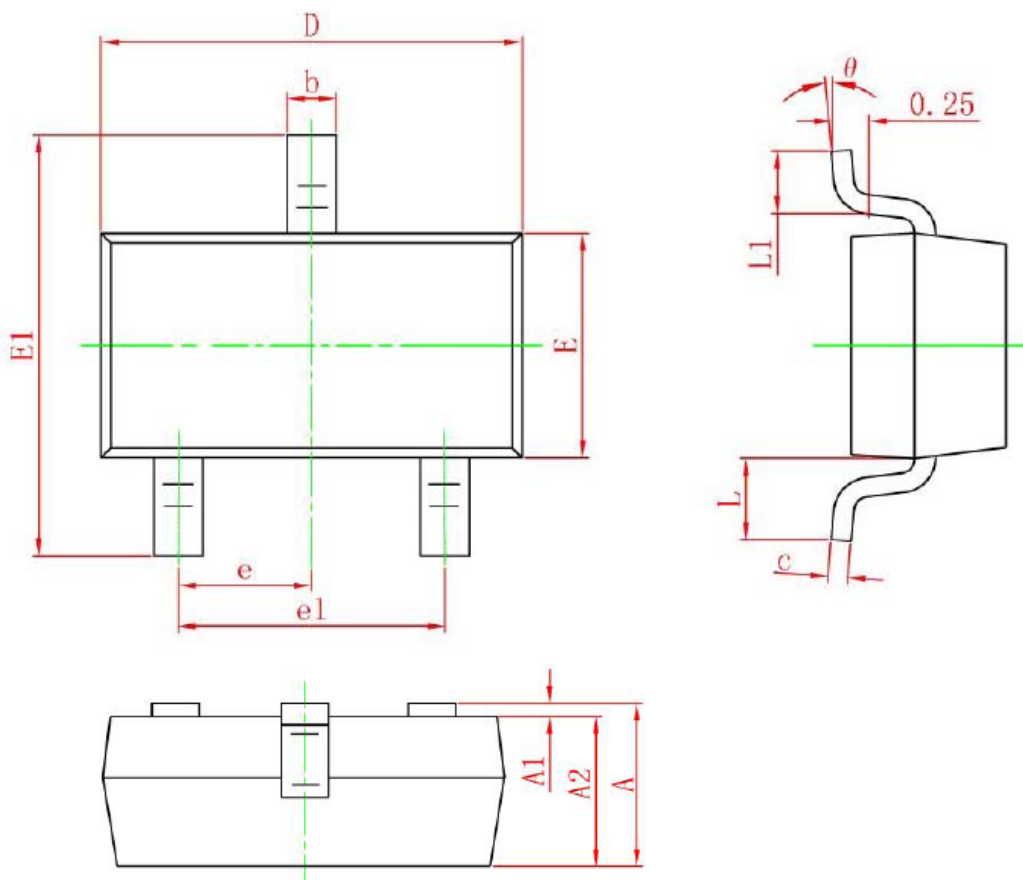

Symbol	Dimensions In Millimeters		Dimensions In Inches	
	Min.	Max.	Min.	Max.
A	0.900	1.150	0.035	0.045
A1	0.000	0.100	0.000	0.004
A2	0.900	1.050	0.035	0.041
b	0.300	0.500	0.012	0.020
c	0.080	0.150	0.003	0.006
D	2.800	3.000	0.110	0.118
E	1.200	1.400	0.047	0.055
E1	2.250	2.550	0.089	0.100
e	0.950 TYP.		0.037 TYP.	
e1	1.800	2.000	0.071	0.079
L	0.550 REF.		0.022 REF.	
L1	0.300	0.500	0.012	0.020
θ	0°	8°	0°	8°

The SINO-IC logo is a registered trademark of ShangHai Sino-IC Microelectronics Co., Ltd.

© 2005 SINO-IC - Printed in China - All rights reserved.

SHANGHAI SINO-IC MICROELECTRONICS CO., LTD

Add: Building 3, Room 3401-03, No.200 Zhangheng Road,
ZhangJiang Hi-Tech Park, Pudong, Shanghai 201203, China

Phone: +86-21-33932402 33932403

33932405 33933508 33933608

Fax: +86-21-33932401

Email: webmaster@sino-ic.com

Website: <http://www.sino-ic.com>